

Model 329 Multiaxial Spindle-Coupled Road Simulators

The Ultimate Testing Solution for the Most Demanding Road Simulation Challenges

THE INDUSTRY-LEADING **MTS MODEL 329 SPINDLE-COUPLED ROAD**

SIMULATOR PROVIDES UNMATCHED SIMULATION ACCURACY AND

REPEATABLE REPRODUCTION OF THE WORLD'S MOST CHALLENGING

PROVING GROUND ROAD SURFACES, MANEUVERS AND EVENTS.



Meeting Your Most Demanding Road Simulation Challenges

MULTIAXIAL SIMULATION

Model 329 road simulators are multiaxial vehicle loading systems optimized to deliver accurate test results. You can run road simulation tests with six-degree-of-freedom control of these forces and moments per corner:

- » Vertical
- » Lateral
- » Longitudinal
- » Brake/drive torque
- » Camber moment
- » Steer moment
- » Steer displacement (optional)
- » Steering wheel displacement (optional)

OFFERING SIX DEGREES OF FREEDOM

The Model 329 6DOF system brings even more of the test track into the laboratory. It offers advanced capabilities never before available in a standard road simulation system. Previously, vehicle laboratories worldwide employed MTS Model 329 and earlier systems, controlling three, four and five degrees of freedom. The Model 329 simulator is the first road simulator for passenger cars that offers six-degree-of-freedom control.

Advantages of the MTS Model 329 6DOF Road Simulator

- » Time and cost savings – It provides more complete simulation information for modeling, analysis, design and virtual testing because it completely reproduces all multiaxial spindle loads. It also eliminates uncontrolled responses, resulting in faster system convergence.
- » Improved testing capabilities – It improves simulation correlation for durability testing, provides greater available range of brake clearance, and reduces the possibility of interference with smaller wheel housings due to the straight vertical struts.

MTS Model 329 Spindle-Coupled Road Simulators are MTS' advanced solution to the automotive industry's vehicle development needs and challenges. With these road simulators, up to six degrees of freedom are coupled with the most advanced durability testing capabilities and the highest laboratory simulation accuracy available anywhere.

The Model 329 road simulator will save you time and money. Significant time progression provides faster lab testing times. Repeatability allows you to quantify your results and save even more time. With the Model 329 simulator, you can deliver your product to market faster.

Unmatched Accuracy

By simulating the multiaxial inputs to the vehicle, Model 329 road simulators replicate the true multiaxial stress state of the structure at any instant in time. Through years of experience and design refinement, MTS has developed road simulator technology that dependably and accurately reproduces forces and moments at the vehicle spindle and throughout the entire vehicle.

Ideal for Component Development

Because of the simulation accuracy achieved with MTS road simulators, test engineers can spin off component tests as they identify critical subsystems for further, more detailed evaluation. Instead of instrumenting a test vehicle and driving it over the proving grounds, they can collect data directly from the road simulator.

Proven in the Lab

The Model 329 road simulator is a product of more than 30 years of experience. MTS is the pioneer of single and multiaxial simulation, and with our Remote Parameter Control™ (RPC®) software technology, we deliver unmatched accuracy and control options to your road simulation testing.

Responsive Service and Support

We are dedicated to providing the support you need to keep your system in top running condition. Our field service engineers are experienced, thoroughly trained and supported by a large inventory of spare parts across the globe. No matter where you are, you are close to a knowledgeable MTS service engineer who has immediate access to replacement components.

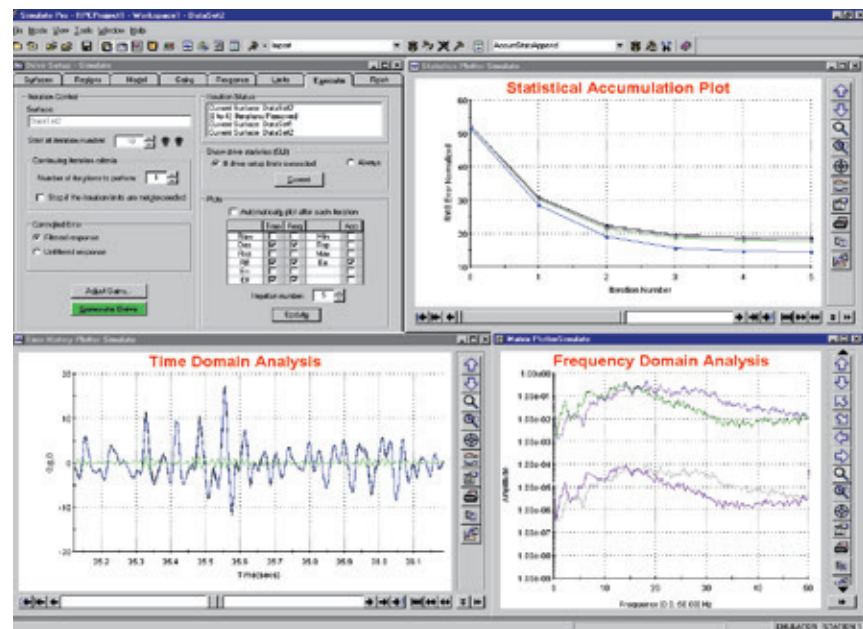

TEST CONFIGURATIONS

- » **Floating Body (24 channels)** –
This full-vehicle test provides the most accurate overall stress distribution in the complete vehicle structure for non-maneuvering events. The vehicle body is allowed to float, and all loads are reacted by its inertia.
- » **Fixed Body (12 channels)** –
This single-axle test produces accurate loads in the vehicle suspension, and allows simulation of maneuvering events (braking and cornering) along with rough road simulation. The vehicle body is grounded, or the suspension can be mounted into a fixed reaction frame.
- » **Semi-Floating Body (12+1 channels)** –
This single-axle test produces accurate loads in the vehicle suspension and a portion of the vehicle body. One axle is grounded through a yaw or yaw-twist fixture while the body is allowed to float. Simulation of braking events is possible in this configuration.
- » **Semi-Active Longitudinal Restraint** –
This full-vehicle test provides the most accurate overall stress distribution for non-maneuvering events, and the best overall simulation of braking events on a free body system. The vehicle body is allowed to float during rough road events, and a longitudinal restraint locks the vehicle body for braking events.

Flexible Configuration Options Meet Your Every Need

Your configuration options are wide open with the Model 329 road simulator technology. You can configure a single corner as a quarter-car suspension development system, two corners to test a half-car or suspension subsystem, or four corners to test a complete vehicle.

Whole vehicle testing using rough road surfaces is performed in the “floating body” mode. Four corners of Model 329 fixturing support the entire vehicle, and the input forces are reacted by the inertia of the specimen.

For suspension testing, where low-frequency maneuvering events (such as cornering and braking) contribute significantly to damage, the vehicle body is grounded and testing is performed on one or both axles. A “semi-floating” body test involves grounding one axle through the spindles. This allows you to perform real-time braking, maneuvering and rough road simulation on half of the car.

Model 329 6DOF systems are commercially available for a wide range of vehicle sizes and applications – small to full-size passenger cars, light trucks and even heavy industrial vehicles. Our offerings include a medium steer test system to test steering and suspension systems and components, and a long stroke system for passenger cars and light trucks that simulates low-frequency, free-body handling events.

Controller and software options for your Model 329 road simulator integrate seamlessly with other MTS products, such as MTS MAST™ systems and MTS Model 320 Tire-Coupled Road Simulators (“four posters”). You can get a complete set of tools that addresses all your structural testing needs, and can connect these systems through an internet network to share results with modeling and development labs. MTS application engineers will work with you to help determine which Model 329 road simulator options best support your testing objectives.

Model 329 6DOF System Overview

The Model 329 6DOF system provides six-degree-of-freedom control of forces and motions at each vehicle spindle: (1) vertical translation; (2) lateral translation; (3) longitudinal translation; (4) brake/drive torque; (5) camber moment; and (6) steer moment. By utilizing proven linkage-coupled technology with independent actuation, the Model 329 6DOF system enables accurate replication of the true multiaxial stress state of vehicle subsystems and components at any instant in time to simulate the complex nonlinear events required for meaningful durability road simulation.

ACCURATE AND POWERFUL CONTROL CAPABILITIES

With the Model 329 6DOF system, road simulation has never been more precise:

- » Accurate reproduction of dynamic tire loading
- » Accurate load distribution in the specimen
- » Accurate load input vectors
- » Uncontrolled responses are eliminated, resulting in:
 - Faster system convergence
 - Superior correlation from remote transducers
 - No need to make judgment calls on uncontrolled channels

Six-degree-of-freedom control at the spindle means that you can run your simulations without compromising the assumptions that typically govern four- and five-degree-of-freedom simulations.

With six degrees of freedom:

- » You can achieve force relationships/ fixed moments even for quasi-static testing. This is because vehicle tire rolling radius and input load offset will vary dynamically during road events.
- » The acceleration of offset tire/wheel inertia will not generate dynamic spindle moments on the road, and uncontrolled simulator moment loads will be correct.
- » A rigid body spindle housing with six control inputs will reliably generate frequency-dependent loads at the spindle. This will eliminate phase angles between spindle forces and moments.

Tested Systems and Subsystems

- ① Suspension
- ② Suspension to body interface
- ③ Body
- ④ Body-mounted components (mirrors, fuel tanks, battery mounts)
- ⑤ Interior parts (seats, IP, steering column)
- ⑥ Exhaust system
- ⑦ Drivetrain mounts (with drive torque option)
- ⑧ Steering system (only with steering input option)

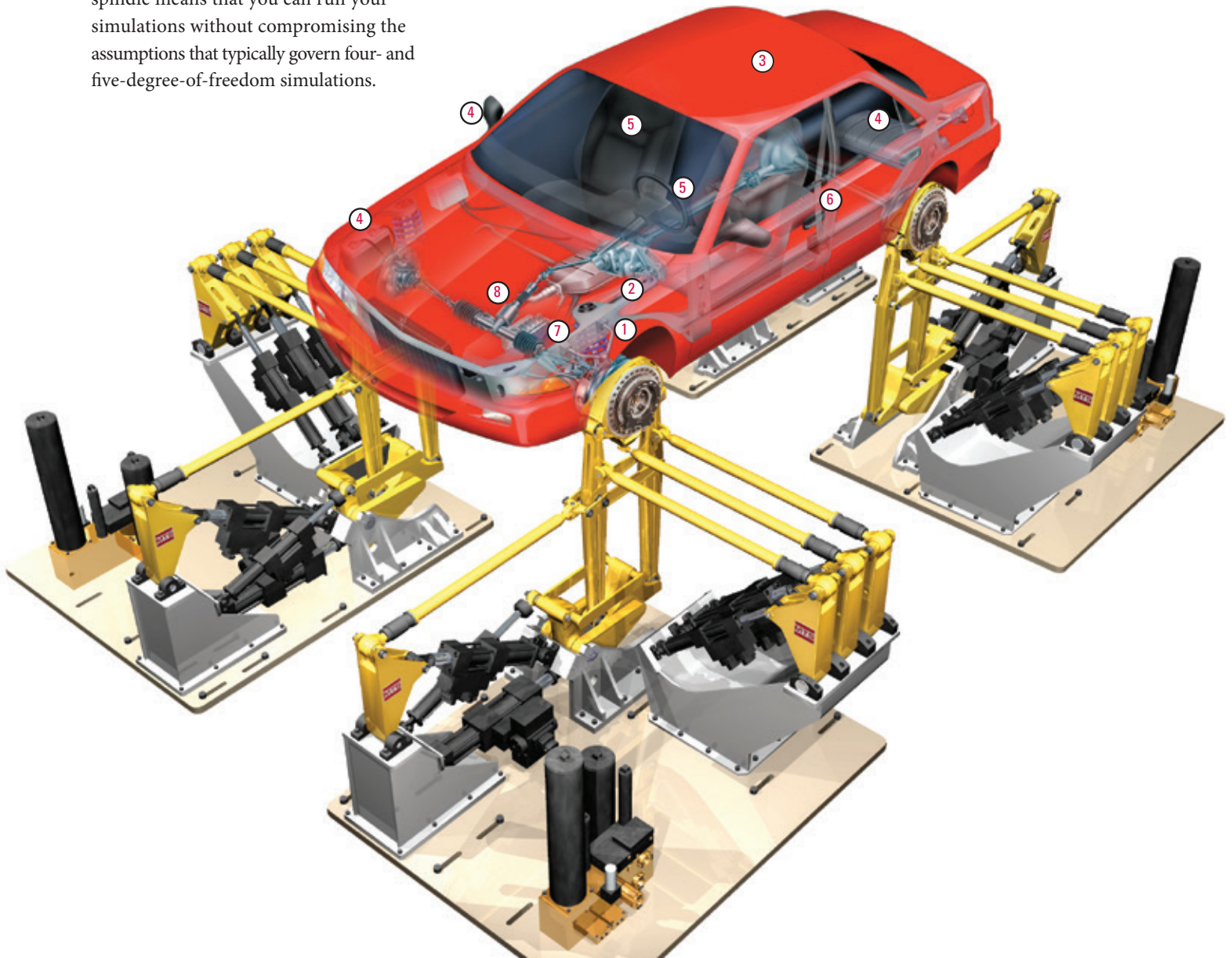

Evolving to Deliver Superior Road Simulation Performance

For decades, MTS has continually evaluated available technologies in its quest to deliver the most accurate and usable replication of road conditions for laboratory-based durability testing. Other providers of testing solutions utilize direct actuator-coupled (or hexapod) technology, which comprises arrangements of six identical, kinematically dependent actuators at each corner of the vehicle.

MTS has instead chosen to use application-specific, linkage-coupled technology. This technology is characterized by arrangements of kinematically independent actuators, optimized to deliver inputs to each specific axis. Systems employing kinematically independent actuators allow for more simple and direct measurement and monitoring of dynamic loads, and therefore provide more effective control during the replication of complex and dynamic nonlinear events.



MTS Model 326 3DOF System

MTS Model 326 3DOF System

- » Lightweight struts provided high fidelity response.
- » Kinematic independent design resulted in ease of control.
- » Bell cranks insulated actuators from specimen motions, increasing system stiffness.

MTS Model 327 4DOF System

- » Automakers quickly embraced the first 4DOF system.
- » Brake/drive was a critical tool for accelerating the development process.
- » More than 40 custom versions were developed for automakers to meet specific testing needs, and more than 200 corners of 4DOF systems are still used by automakers worldwide.

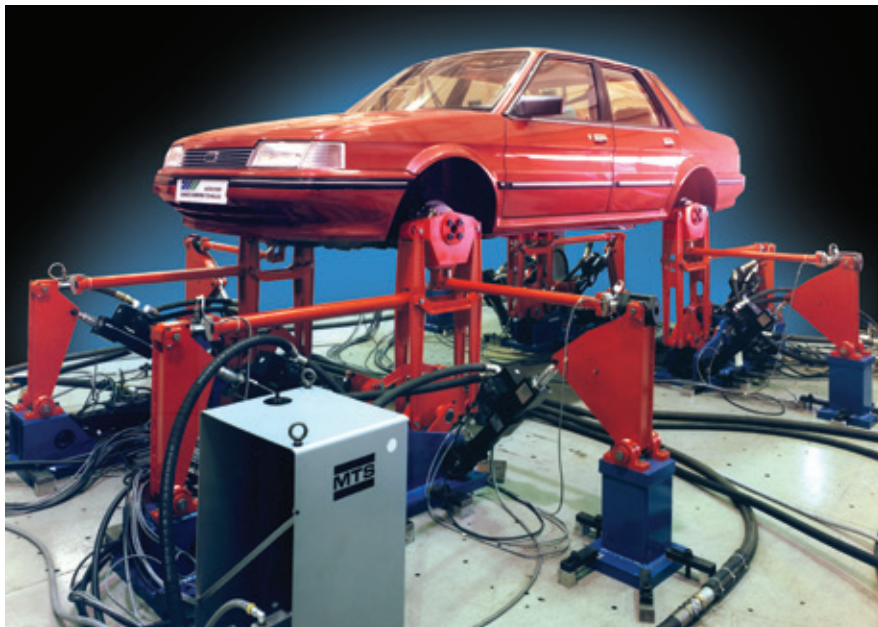

MTS Model 327 4DOF System

MTS Model 329 5DOF System

- » The Model 329 system with five degrees of freedom emerged from the developments of the Model 329 4DOF system.
- » It provided vertical, lateral, longitudinal, brake/drive and steer torque capabilities.

MTS Model 329 6DOF System

- » The Model 329 6DOF system is the first passenger car simulator with six-degree-of-freedom control of forces and motions at the vehicle spindle.
- » Three lateral struts work together to provide lateral force control with the addition of steer and camber moment control.
- » In addition to complete force and moment control at the spindle, the Model 329 6DOF system can be delivered in a version designed to provide steering displacement control.
 - Standard configuration provides ± 8 degree steering angles.
 - Axle test configuration and long stroke configuration provide ± 25 degree steering angles.
 - Turntable configuration provides ± 45 degree steering angles.
- » From the beginning, the Model 329 6DOF system was designed to work with MTS wheel force transducers. The result is fast drivefile convergence.

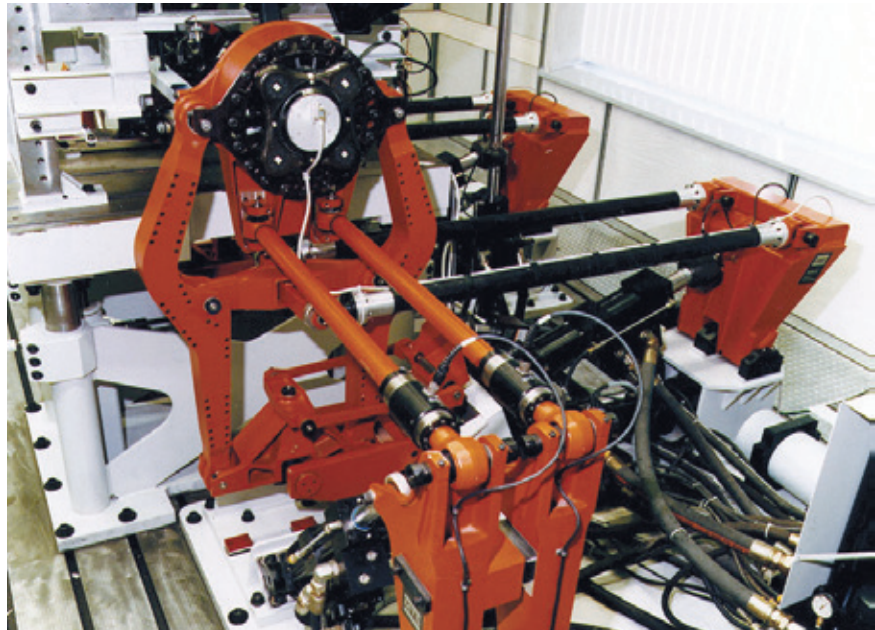

MTS Model 329 5DOF System



MTS Model 329 6DOF System

Delivering Versatile, High-Performance Digital Control

The MTS FlexTest® 200 Digital Controller is the latest and most advanced road simulation control solution available. Designed specifically for high-channel-count vehicle simulation testing, it employs a proven VME-based MTS architecture to deliver the advanced functionality, superior test control and configurability required to take full advantage of the Model 329 system's broad road simulation capabilities.

Proven MTS Control, Simulation and Data Management Software

The PC-driven FlexTest 200 controller employs MTS Series 793 control software to provide a high-performance simulation environment robust enough for the most demanding road simulation applications. This powerful control package allows you to define new tests, acquire data and analyze results of previous tests while current tests are still in progress.

As with all FlexTest digital controllers, the FlexTest 200 system allows you to take advantage of a broad array of proven MTS test application software packages.

For road simulation applications, foremost among these is RPC Pro software – the world's most widely used road simulation software. The FlexTest 200 controller integrates seamlessly with RPC Pro software through the test server to deliver highly accurate replications of multi-axial time-based measurements for simulating the field service of full vehicles and components. RPC Pro software optimizes the complete road simulation process, providing system control and general data analysis. Its process-driven applications focus on streamlining data acquisition, data analysis and durability test operation.



The control system's utility is further enhanced through the use of other MTS packages such as eTIM™ (electronic Test Information Management) software for efficiently managing and archiving test information.

Additionally, a number of adaptive control compensation options are available for use in your tests. These include Null Pacing, Peak-Valley Control, Amplitude Phase Control and Adaptive Inverse Control. You can choose the best technique for each of your testing needs.

Superior Control Functionality

The FlexTest 200 controller delivers an unmatched variety of road simulation control features, including support for calculated channels, sophisticated event-action processing and mode-switching.

Calculated channels allow the creation of feedback parameters that comprise combinations of multiple physical parameters. These in turn can provide enhanced capability for monitoring, and

limit-checking, as well as RPC and closed-loop control. Calculated channels also lend flexibility to matrix control algorithms, which drive combinations of transducers and actuators to provide modal control of compression loads, shear, translation displacements, steer, toe, camber, rack and yaw. Advanced users can leverage this flexibility to respond effectively to changing test demands.

Event/action processing enables users to create special interlocks and events based on digital I/O, limit detectors, error detectors and system events.

Mode-switching enables a user to shift between feedback modes depending on the state of the test specimen. For example, switching from displacement to load control for braking simulation, or to a composite-feedback mode for steering simulation. Mode-switching also allows shifting between modes that employ the same feedback, but use different loop tuning characteristics, limit settings and so forth.

Specimen Monitoring

FlexTest 200 controller functionality includes a variety of specimen monitoring options to track specimen degradation.

Trend monitoring allows a user to monitor the trends of key statistics for up to 16 data signals. Limits can be set based on first pass data, triggering various system actions when tripped.

Fatigue Monitoring records cycles in a histogram and then calculates specimen damage based on the accumulated data. Three rainflow-counted histogram types are supported: RangeMean, Range and MaxMin. Data limits can be set and adjusted online, and accumulated data can be viewed in graph form.

Flexible Data Acquisition

The FlexTest 200 controller can accommodate up to 96 data acquisition channels. Test data can be acquired at standard RPC rates for synchronization with time history playouts. Other features include digital FIR filters for anti-aliasing and realtime X,Y plotting. The control system supports user-configurable report generation using RPC Pro software or Microsoft® Office tools.

Broad Configurability

The multistation FlexTest 200 controller eliminates the need to swap cables and circuit boards when changing channel assignments, allowing your lab to adapt quickly and efficiently to evolving simulation requirements. The system features more than 30 direct digital control channels for driving the most comprehensive road simulator arrangements, with additional control channels available for optional functionality such as axle wind-up and longitudinal restraint. A single FlexTest 200 controller can easily be configured to perform 2-corner, 4-corner, fixed body or inertial reaction tests.

Safe, Streamlined Test Setup

The FlexTest 200 controller features an intuitive, graphical user interface and broad array of configuration files and setup capabilities to streamline the definition and running of tests.

Available in numerous languages, the user-definable FlexTest 200 interface includes a two-channel digital oscilloscope with time-base, frequency-base or X,Y display modes; digital volt meters with peak/valley, max/min or continuous update modes; summary displays; and a system status panel. Signals can be renamed and grouped into signal, detector and group control lists for quick access and interpretation. Function generation includes time history playback, cyclic sine and broad-band frequency weighted random signal generation – soft start/stop is part of all functions.

To ensure test repeatability, setup and calibration data – including tuning/ stability terms, filters and compensators – can be archived on disk for quick recall. Additional features such as master setpoint, remote setpoint adjust, remote install car pods and user-definable home and park positions further enhance the safety and ease of specimen installation and system troubleshooting.

Network Connectivity

Integrating the FlexTest 200 control system into your organization's computer network to share test data among multiple operators is simple and straightforward. RPC Pro software tools can be used on the FlexTest 200 computer or on a separate PC over a dedicated Ethernet connection. A second Ethernet connection is provided to enable network file transfer with other PCs.

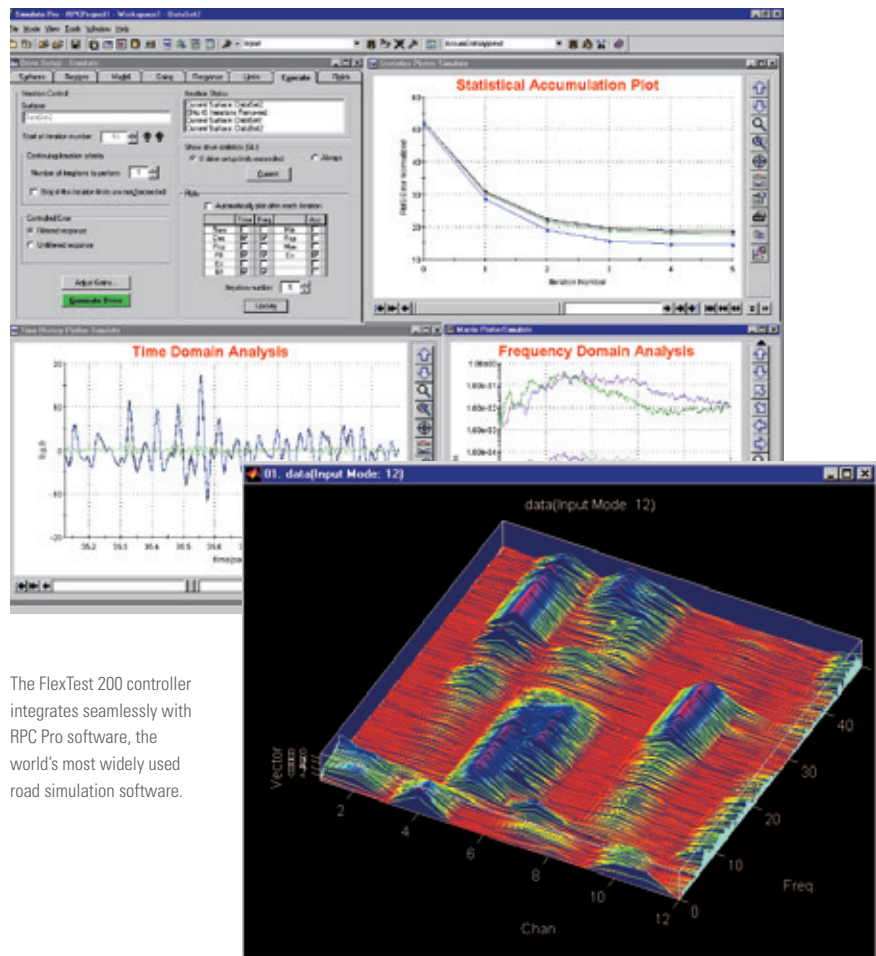

The FlexTest 200 controller integrates seamlessly with RPC Pro software, the world's most widely used road simulation software.

MTS Road Simulator Solutions

Long Stroke System

The Long Stroke System offers the large displacement capability needed for braking and slalom (lane change) events. In fact, MTS delivers the largest displacement capability in the marketplace. The Long Stroke System provides 1.2 meter (3.93 feet) lateral and longitudinal spindle displacement to increase the simulation bandwidth of the system. This additional displacement provides the ability to reproduce lower-frequency events on free body tests, improving the reproduction accuracy of maneuvering events such as cornering and braking.



Long Stroke System

Motorcycle, All-Terrain Vehicle and Other Small Vehicles

The MTS Model 334 Four-Corner Road Simulator accurately replicates the forces and motions experienced by motorcycles, ATVs and other small vehicles on the road, track or trail. It simulates the vertical and longitudinal road inputs both at the front and rear axles. Human rider dynamics are achieved through the use of a mechanical rider. Mechanical linkages restrain the rider during testing to simulate the rider's inertia during lateral and roll motions. For more demanding simulation requirements, active restraint systems can also be added. This simulator significantly reduces test time and saves money. It is 10 to 20 times faster than street testing and 4 to 10 times faster than test track testing.



MTS Model 334 Four-Corner Road Simulator

Model 329 Heavy Truck System

Model 329 test fixtures are engineered in three sizes: passenger car (Model 329), light truck (Model 329 LT) and heavy truck (Model 329 HT). As the same design principles apply to all three fixtures, the Model 329 HT test fixture can be deployed in the same way as its passenger car equivalent to perform highly accurate six-degree-of-freedom body and suspension tests for the heaviest vehicles on the road.

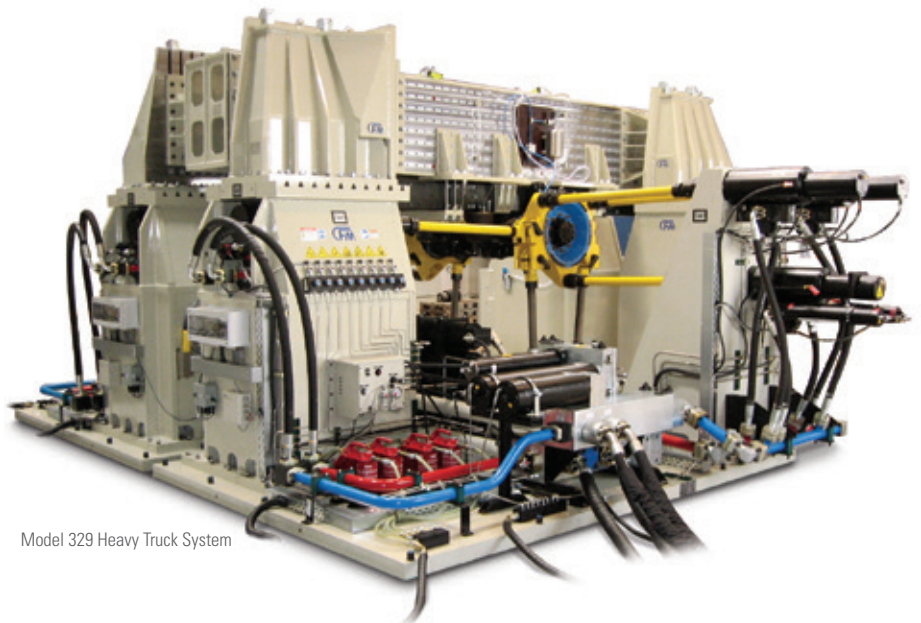

Model 329 Heavy Truck System

Environmental Road Simulation

A Model 329 4DOF road simulator totally enclosed within an advanced environmental chamber enables you to perform full-vehicle durability simulations under extreme temperature, humidity and solar loading conditions. A heavy-duty version of this system provides active vehicle restraint and four-degree-of-freedom durability simulation on larger vehicles. It accommodates up to a four-meter wheel-base and is capable of handling a large, 3,492 kg (7,700 lb) vehicle.

For severe environment testing, including corrosion and excessive humidity, the struts can reach through the chamber walls to provide the dynamic loading for the specimen under test.



Model 329 4DOF Road Simulator

Steer Simulation

Proven Model 329 road simulator technology is employed to replicate steering loads for steering component durability testing. An actuator mounted on the steering column of the vehicle drives the steer subsystem. The fixture corners provide 50-degree rotation to reproduce the desired steer displacements and loads. 90-degree rotation test systems are also available from MTS.

By steering the wheels, the longitudinal and lateral forces become vectored into the suspension more realistically. The steer moment force (a moment around the vertical axis) accurately reproduces the differential lateral force in suspension components.

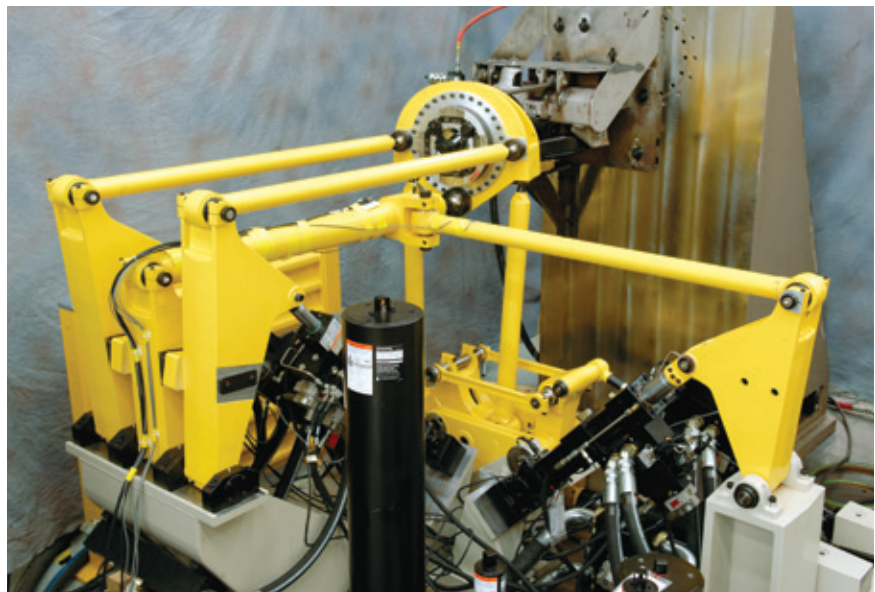

Model 329 Road Simulator

MTS Road Simulator Test Fixturing

1. Independent Brake Channel

Because the brake channel is completely independent, it is not subjected to crosstalk. The power requirement for the brake actuator is significantly reduced, and the error from uncontrolled interactions is eliminated. The brake actuator may be held stationary for non-braking events without affecting the other channels, while allowing the vehicle brakes to be applied dynamically during the simulation.

2. Bearings

The bearings in the vertical load train and at the strut ends consist of elastomeric outer bushings with needle roller inserts. The rolling elements provide the primary axis of motion, while the rubber bushing allows the swivel (spherical) motion. This design results in a long, maintenance-free life with little wear or backlash.

3. Struts

The large-diameter, thin-wall, low-mass design of the struts ensures that resonant frequencies remain well outside the test bandwidth. The unique configuration of the longitudinal and vertical channels provides a pure vertical straight-line locus at the spindle center, with minimal compensation from the longitudinal channel.

4. Load Transducers

The load transducers used on the Model 329 struts are specifically designed by MTS engineers for this application. The hollow tubular construction maintains a consistent load path with the tubular struts.

They are designed to withstand multiaxial vibration with minimal crosstalk. They are fatigue rated at forces well above their operating loads and meet the accuracy standards for which MTS is famous.

5. Actuators and Servovalves

Each actuator uses a large-diameter, single-piece piston rod that is precision-ground and chrome-plated. These design features ensure high strength, lateral stiffness and low wear. The thick-walled cylinder ensures overall rigidity and has a high transverse resonant frequency. The displacement transducer is coaxially mounted within the hollow piston rod for accuracy and protection. Built-in hydraulic cushions protect the end caps under full-stroke, high-velocity operation.

The servovalves are three-stage devices specifically designed and precision-engineered for the critical requirements of high flow, high response and low distortion. They feature electronic feedback of the spool position for enhanced dynamic response. Matched ground metering edges minimize crossover distortion, and high spool-driving force combines with hardened tool steel edges to reduce the valve sensitivity to contamination.

6. Bell Cranks

Bell cranks are employed for all applied forces. They reduce demands on the actuator bearings, increasing their life, and they eliminate the need for oil-consuming hydrostatic bearings. They also resolve all horizontal loads into vertical reactions. This eliminates the need for actuator mounting stanchions and reduces the overall area and weight required for the simulator.

The MTS Model 329 road simulator integrates robust mechanical testing equipment, reliable hydromechanical systems, versatile digital control and state-of-the-art software to bring the test track into your laboratory and facilitate more accurate, repeatable and accelerated vehicle and component durability testing.

Our attention to detail in the Model 329 test fixture design results in many advantages. A significant benefit is reduced kinematic crosstalk. Because crosstalk between channels is minimized, MTS Remote Parameter Control software accurately reproduces forces and moments at the point of excitation, as well as in remote areas of the suspension and vehicle structure. Another benefit is our careful selection of long-life, minimal maintenance components.

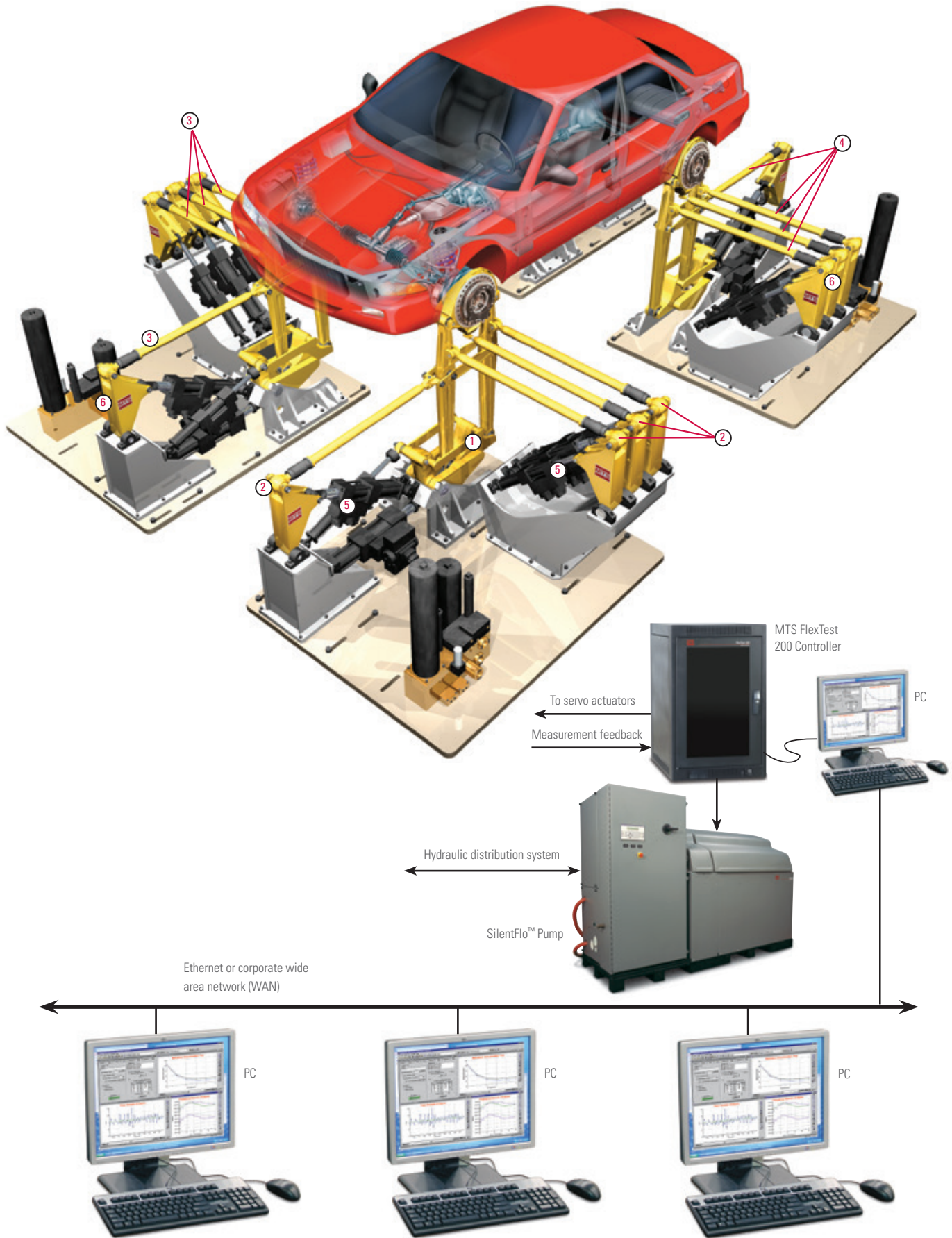

MTS Road Simulator Accessories

MTS offers a wide range of accessories to enhance the functionality of your Model 329 system. By using these tools, you can increase the value of your tests because they allow you to include more components in the simulation, reduce the time it takes to develop a test and provide more information from a given test.

Brake Intensifier Package

For accurate testing, it is beneficial to clamp the brakes during braking events only, and release them for the remainder of the test. This is because when brakes are applied, the load path through a vehicle suspension is altered (especially with disk brakes). As a result, the brake pads and caliper become a parallel load path for spindle forces and moments. To offset this problem, MTS offers an air-over-fluid pressure intensifier to energize the vehicle brakes. The package works in the same way as power-assisted brakes, replacing the master cylinder. The control solenoid is connected to the digital interface, and the result is a computer-controlled braking system. The brake torque control electronics are designed to operate in low-gain stroke control when the brakes are released and in load control when they are applied.



Yaw-Twist Fixture

This accessory provides complete freedom for vehicle yaw axis motion so that when the opposite axle is translated laterally, no reaction force is generated by the fixture itself. The axle under test is installed into two corners of standard Model 329 fixturing. The other axle is restrained with the tire-coupled Yaw-Twist Fixture.

One parameter that is not reproduced well with half-vehicle simulation is twist (when each axle rolls out of phase). The Yaw-Twist fixture resolves this problem by including an extra actuator channel that applies low frequency roll to the restrained axle to allow accurate replication of twist events.



Torque Input Fixture

With the standard Model 329 simulator, torque is applied at each wheel to simulate brake torque via locking of the vehicle brakes. To simultaneously simulate engine torque (or drive torque), MTS offers its bi-directional Torque Input Fixture. It mounts on the engine, transmission or rear axle, and the bottom of the fixture bolts to ground. Whether the simulation is free, semi-free or fixed, the fixture does not introduce significant erroneous loads in uncontrolled directions (vertical or horizontal).



Semi-Active Longitudinal Restraint System

When combined with the Brake Intensifier Package, the Semi-Active Longitudinal Restraint System provides complete dynamic control of the simulation mode. During non-braking events, the vehicle body floats naturally. When a braking event is encountered, the longitudinal restraint and the brakes lock to provide a reaction to ground. The restraint system is fixed to the front and rear of the vehicle structure through the bumper mounts. Actuators are coupled through airbags, bell cranks and struts. The airbags deflate during non-braking events, effectively decoupling the restraint.

SWIFT® Evo Wheel Force Transducers

Combining a SWIFT Evo Spinning Wheel Integrated Force Transducer with the Model 329 6DOF system presents an ideal means for streamlining and accelerating the simulation of suspension loads. SWIFT Evo transducers feature a high stiffness one-piece design that yields high sensitivity, excellent linear behavior and high overload capacity. Unique among wheel force transducers, this design delivers unmatched precision and long life, enables easy installation and measures loads directly at the spindle, eliminating the need to convert data.

Data generated with SWIFT Evo transducers are useful for many applications, including analysis, design, and modeling of the system for creation of virtual models, and application in virtual testing. They quickly attach to a modified rim for data acquisition on the road or in the lab, significantly reducing instrumentation time and costs.

The SWIFT Evo system is currently available in seven sizes—ranging from the SWIFT Evo 10 for motorcycles, up to the SWIFT Evo 60 for heavy industrial and agricultural vehicles.



Rail Car Transportation Simulation

The Rail Car Transportation Simulation option is comprised of a platform that mounts to the four corners of the Model 329 fixturing and accurately reproduces the shipping environment experienced by vehicles. This option, manufactured to meet your particular specifications, further increases your testing lab's capabilities and flexibility.



Downforce System

The Downforce System reproduces the aerodynamic loads on the vehicle. It applies force to the specimen while presenting a soft path to ground. As the moving specimen presents an external disturbance to the load control loop, the system reacts by moving along with the specimen, maintaining the commanded load.

Applications of this system include:

- » Aerodynamic downforce and control surface load simulation
- » Simulation of inertial forces due to cornering and braking
- » Active test vehicle restraint for road simulation systems
- » Models are available that meet NASCAR, Open Wheel and Formula One racing standards.

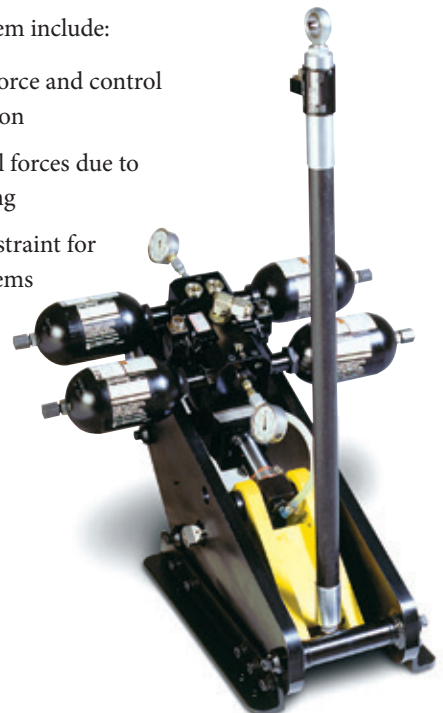

Unparalleled MTS Global Support

Since 1966, the global automotive community has turned to MTS Systems Corporation for innovative testing and simulation systems that enhance productivity and engineer safer, cleaner and more durable products. MTS is recognized as the premier provider of full-vehicle, subsystem and component-level testing systems and software, with unparalleled engineering and technical experience and a growing set of core technologies.

Consulting and Engineering Services

UNDERSTANDING YOUR NEEDS

With reduced development cycles and innovative design requirements, you need to maximize the efficiency and effectiveness of your vehicle and component testing efforts. Whether your needs are large or small, MTS has the expertise and the resources to understand your challenges and complement your skills wherever needed. We are capable of providing daily or weekly consulting to meet urgent immediate needs, or we can propose engineering studies, comprehensive training and development programs to address longer-term concerns.

GUIDING YOU THROUGH EVOLVING TECHNOLOGY

By working closely with vehicle manufacturers across the globe, MTS consultants have acquired core competencies in testing components, subsystems and full vehicles. This wealth of real-world experience can be readily transferred to your organization to help you keep abreast of evolving vehicle- and component-testing technologies and their applications. We also offer design, analysis and modeling solutions to complement these tests.



ANALYZING YOUR PROBLEMS

MTS has a proven record of success in providing creative solutions to both product- and process-oriented problems for virtually all areas of vehicle development. Our exposure to a wide variety of applications and vehicle development problems enables us to propose innovative solutions to your most difficult problems in a timely and cost-efficient manner.

Solutions may include:

- » Alternative simulation techniques
- » Control system evaluation and modification
- » Instrumenting complex specimens
- » Mechanical problem identification and resolution
- » Prototype system development

PROPOSING COMPLETE ENGINEERING SOLUTIONS

- » Customized training
- » Co-development projects
- » New methods, techniques and technologies
- » Visual Basic®/ batch file custom projects
- » Advanced engineering studies
- » Equipment and resource supplementation

The MTS Maintenance, Enhancement and Support (ME&S) Agreement

Software technologies continue to change rapidly in our industry. This can create many challenges when trying to keep systems current and compatible with evolving PC technology, while meeting increasing workload demands. MTS offers a Maintenance, Enhancement and Support (ME&S) agreement that makes it easy and cost-effective to maintain and enhance your systems, with the assurance that experienced MTS technical support is waiting to help you. With an ME&S agreement from MTS you will receive:

AUTOMATIC UPDATES, INCLUDING

- » New features added to your software in response to demands from the testing community.
- » All software updates that become available after initial program purchase.
- » New capabilities added to your previously purchased software packages.
- » New software that stays compatible with evolving PC operating systems.

EASIER BUDGETING WITH FIXED COSTS

An ME&S agreement is more cost-effective than purchasing software upgrades and updates separately.

ASSURED TECHNICAL ASSISTANCE

You will qualify for preferential technical assistance by telephone from MTS software experts at no additional cost.

A PLAN TO FIT YOUR SPECIFIC NEEDS

- » Agreements are purchased at the time of equipment purchase or shortly thereafter. They are sold in 12-month coverage increments; however, you can buy up to 48 months of coverage at the same low annual rate.
- » You qualify for discounts if you have multiple systems.

Responsive Field Service

Our equipment service offerings are designed to maximize uptime and keep your lab running productively. MTS field service engineers are trained professionals, strategically located to provide prompt, technically competent responses to your service needs.

MTS service offerings include:

- » Calibration and verification services to ensure reliable test results.
- » Preventive maintenance to minimize downtime.
- » Scheduled and emergency repair services to bring your testing systems back up and running in the event of a failure.
- » A worldwide parts logistics infrastructure that can supply the parts you need when you need them.

Comprehensive Customer Support

To ensure that you receive the full benefits of your MTS test equipment, we provide a wide range of customer support options. Whether providing assistance with troubleshooting, answering questions about software, or just helping get the job done, our experienced support engineers can help you keep your lab running smoothly.

Productivity-Enhancing Training

All MTS training courses are designed to help you maximize the productivity and lifetime of your test system investment. The courses provide an opportunity for hands-on learning to ensure that you are familiar with every aspect of your test system. Our training courses cover systems and software operation and maintenance, testing principles, methodologies and applications.

Model 329 System Refurbishing

MTS offers complete repair and remanufacturing services. We can transform your aging Model 329 road simulator to like-new operation and update its components to current design standards. For example, your 12-year-old 4DOF system can be refurbished to incorporate all design changes since its purchase. Refurbishing services include rebuilding all actuators, replacing all bearings, and inspecting and replacing all components as needed.



Model 329 Spindle-Coupled Road Simulators System Performance

329i PC 6 DOF

	Vertical Input	Longitudinal Input	Lateral Input	Steer Input	Brake/Drive Input	Camber Input
Max. Operating Frequency	80 Hz	80 Hz	80 Hz	80 Hz	80 Hz	80 Hz
Spindle Force/Moment	63 kN (14,100 lbf)	22 kN (4,950 lbf)	20 kN (4,500 lbf)	6.9 kN-m (61,000 in-lbf)	4.0 kN-m (35,400 in-lbf)	9.6 kN-m (85,000 in-lbf)
Spindle Displacement	±190 mm (±7.5 in)	±196 mm (±7.7 in)	±129 mm (±5.1 in)	±8 deg	±17 deg	±8 deg
Spindle Velocity	7 m/sec (276 in/sec)	2.2 m/sec (86 in/sec)	2.4 m/sec (94 in/sec)	750 deg/sec	700 deg/sec	400 deg/sec

- » Total maximum recommended vehicle mass 3000 kg (6600 lbs).
- » All Performance estimation subject to change.
- » Dynamic specification is based on single axis only, sinusoidal input, non-continuous events
- » Performance values are nominal at mid position – not simultaneous nor corrected for linkage.
- » Maximum brake clearance diameter is 450mm for above performance predictions.
- » Minimum required oil-flow for random loading is approximately 284 lpm (75gpm) per corner.
- » This rating is highly dependent on actual operating conditions and should be discussed further with an MTS Application Engineer.

329i LT 6 DOF

	Vertical Input	Longitudinal Input	Lateral Input	Steer Input	Brake/Drive Input	Camber Input
Max. Operating Frequency	80 Hz	80 Hz	80 Hz	80 Hz	80 Hz	80 Hz
Spindle Force/Moment	77 kN (17,300 lbf)	29.5 kN (6,600 lbf)	33.5 kN (7,500 lbf)	6.9 kN-m (61,000 in-lbf)	6.2 kN-m (54,800 in-lbf)	14.3 kN-m (125,000 in-lbf)
Spindle Displacement	±190 mm (±7.5 in)	±196 mm (±7.7 in)	±129 mm (±5.1 in)	±8 deg	±17 deg	±8 deg
Spindle Velocity	5.0 m/sec (197 in/sec)	3.0 m/sec (118 in/sec)	2.6 m/sec (102 in/sec)	750 deg/sec	450 deg/sec	450 deg/sec

- » Total maximum recommended vehicle mass 6000 kg (13200 lbs).
- » All Performance estimation subject to change.
- » Dynamic specification is based on single axis only, sinusoidal input, non-continuous events
- » Performance values are nominal at mid position – not simultaneous, nor corrected for linkage.
- » Maximum brake clearance diameter is 450mm for above performance predictions.
- » Minimum required oil-flow for random loading is approximately 386 lpm (102 gpm) per corner.
- » This rating is highly dependent on actual operating conditions and should be discussed further with an MTS Application Engineer.
- » Optional static support is capable of providing up to 23 kN (5000 lbf) of additional vertical upforce per corner to offset vehicle weight.

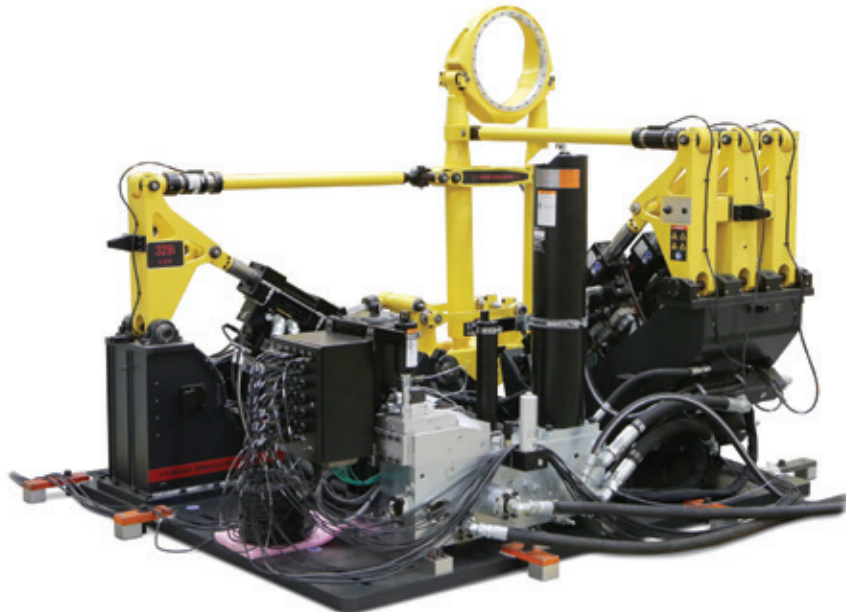

The new 80 Hz Model 329i integrates a diverse array of MTS mechanical, controls and software innovations to meet evolving requirements for connectivity, accuracy, productivity and efficiency.

Model 329 6DOF (Passenger Car)

	Vertical Input	Longitudinal Input	Lateral Input	Steer Input	Brake/Drive Input	Camber Input
Max. Operating Frequency	50 Hz	50 Hz	50 Hz	50 Hz	50 Hz	50 Hz
Spindle Force/Moment	63 kN (14,100 lbf)	22 kN (4,950 lbf)	20 kN (4,500 lbf)	6.9 kN-m (61,000 in-lbf)	4.0 kN-m (35,400 in-lbf)	9.6 kN-m (85,000 in-lbf)
Spindle Displacement	380 mm (15 in)	392 mm (15.4 in)	258 mm (10.2 in)	16 deg	32 deg	16 deg
Spindle Velocity	7 m/sec (276 in/sec)	2.2 m/sec (86 in/sec)	2.4 m/sec (94 in/sec)	700 deg/sec	700 deg/sec	400 deg/sec

- » Total maximum recommended vehicle mass 3000 kg (6,600 lb).
- » All performance estimates are subject to change.
- » Dynamic specification is based on single axis only, sinusoidal input, non-continuous events.
- » Performance values are nominal at mid position – not simultaneous, nor corrected for linkage.
- » Maximum brake clearance diameter is 430 mm for above performance predictions.
- » All displacements are expressed in terms of double amplitude values.
- » Typical required oil-flow for random loading is approximately 284 lpm (75 gpm) per corner. This rating is highly dependent on actual operating conditions and should be discussed further with an MTS application engineer.

Model 329 LT 6DOF (Light Truck)

	Vertical Input	Longitudinal Input	Lateral Input	Steer Input	Brake/Drive Input	Camber Input
Max. Operating Frequency	50 Hz	50 Hz	50 Hz	50 Hz	50 Hz	50 Hz
Dynamic Spindle Force/Moment	77 kN (17,300 lbf)	29.5 kN (6,600 lbf)	33.5 kN (7,500 lbf)	6.9 kN-m (61,000 in-lbf)	6.2 kN-m (54,800 in-lbf)	11.3 kN-m (100,000 in-lbf)
Spindle Displacement	380 mm (15 in)	392 mm (15.4 in)	258 mm (10.2 in)	16 deg	34 deg	16 deg
Spindle Velocity	5.0 m/sec (197 in/sec)	3.0 m/sec (118 in/sec)	2.6 m/sec (102 in/sec)	750 deg/sec	450 deg/sec	450 deg/sec

- » Total maximum recommended vehicle mass 6000 kg (13,200 lb).
- » All performance estimates are subject to change.
- » Dynamic specification is based on single axis only, sinusoidal input, non-continuous events.
- » Performance values are nominal at mid position – not simultaneous, nor corrected for linkage.
- » Maximum brake clearance diameter is 430 mm for above performance predictions.
- » All displacements are expressed in terms of double amplitude values.
- » Typical required oil-flow for random loading is approximately 386 lpm (102 gpm) per corner. This rating is highly dependent on actual operating conditions and should be discussed further with an MTS application engineer.
- » Optional static support is capable of providing up to 23 kN (5,000 lbf) of additional vertical upforce per corner to offset vehicle weight.

Model 329 6DOF Medium Steer

	Vertical Input	Longitudinal Input	Lateral Input	Steer Input	Brake/Drive Input	Camber Input
Max. Operating Frequency	50 Hz	50 Hz	50 Hz	50 Hz	50 Hz	50 Hz
Dynamic Spindle Force/Moment	77 kN (17,300 lbf)	25.8 kN (5,800 lbf)	33.2 kN (7,450 lbf)	8.3 kN-m (73,400 in-lbf)	6.0 kN-m (53,000 in-lbf)	7.2 kN-m (63,700 in-lbf)
Spindle Displacement	300 mm (11.8 in)	200 mm (7.8 in)	200 mm (7.8 in)	50 deg	30 deg	20 deg
Spindle Velocity	6.1 m/sec (240 in/sec)	2.2 m/sec (85 in/sec)	2.5 m/sec (100 in/sec)	700 deg/sec	880 deg/sec	700 deg/sec

- » Total maximum recommended vehicle mass 6000 kg (13200 lb).
- » All performance estimates are subject to change.
- » Dynamic specification is based on single axis only, sinusoidal input, non-continuous events.
- » Performance values are nominal at mid position – not simultaneous nor corrected for linkage.
- » Maximum brake clearance diameter is 420 mm for above performance predictions.
- » All displacements are expressed in terms of double amplitude values.
- » Typical required oil flow for random loading is approximately 386 lpm (102 gpm) per corner. This rating is highly dependent on actual operating conditions and should be discussed further with an MTS application engineer.

Regional Business Centers

THE AMERICAS

MTS Systems Corporation

14000 Technology Drive
Eden Prairie, MN 55344-2290
USA

Telephone: 952-937-4000
Toll Free: 800-328-2255
E-mail: info@mts.com
Internet: www.mts.com

EUROPE

MTS Systems France

BAT EXA 16
16/18 rue Eugène Dupuis
94046 Créteil Cedex

France

Telephone: +33-(0)1-58 43 90 00
E-mail: contact.france@mts.com

MTS Systems (Germany) GmbH

Hohentwielsteig 3
14163 Berlin

Germany

Telephone: +49-(0)30 81002-0
E-mail: euroinfo@mts.com

MTS Systems S.R.L. a socio unico

Strada Pianezza 289
10151 Torino

Italy

Telephone: +39-(0)11 45175 11 sel. pass.
E-mail: mtstorino@mts.com

MTS Systems Norden AB

Datavägen 37b
SE-436 32 Askim

Sweden

Telephone: +46-(0)31-68 69 99
E-mail: norden@mts.com

MTS Systems Limited

98 Church Street,
Hunslet,
Leeds
LS102AZ

United Kingdom

Telephone: +44 (0) 113 270 8011
E-mail: mtsuksales@mts.com

ASIA/PACIFIC

MTS Japan Ltd.

Raiden Bldg. 3F 3-22-6,
Ryogoku, Sumida-ku,
Tokyo 130- 0026

Japan

Telephone: +81 3 5638 0850
E-mail: mtsj-info@mts.com

MTS Korea, Inc.

2nd F, Bundang Yemiji Building, 31,
Hwangsaoul-ro 258beon-gil,
Bundang-gu, Seongnam-si,
Gyeonggi-do, 13595

Korea

Telephone: +82-31-728-1600
E-mail: mtsk-info@mts.com

MTS Systems (China) Co., Ltd.

Floor 34, Building B,
New Caohejing International
Business Center,
No.391, Guiping Road,
Xuhui District
Shanghai 200233

P.R.China

Telephone: +021-24151000
Market: +021-24151111
Sales: +021-24151188
Service: +021-24151198
E-mail: MTSC-Info@mts.com

MTS Testing Solutions Pvt Ltd.

Unit No. 201 & 202, Second Floor
Donata Radiance,
Krishna Nagar Industrial Layout,
Koramangala, Bangalore - 560029
Karnataka, India
Telephone: + 91 80 46254100
Email: mts.india@mts.com



MTS Systems Corporation
14000 Technology Drive
Eden Prairie, MN 55344-2290 USA

ISO 9001 Certified QMS
<http://www.mts.com>

MTS, FlexTest, RPC and SWIFT Evo are registered trademarks, and ERPC, eTIM, MAST, Remote Parameter Control and SilentFlo are trademarks of MTS Systems Corporation within the United States. These trademarks may be protected in other countries. RTM No. 211177.

Microsoft, Windows and Visual Basic are registered trademarks of Microsoft Corporation.

©2023 MTS Systems Corporation
100-109-160f Multiaxial329 • Printed in U.S.A. • 08/23