

MTS Criterion® & Exceed® Accessories

Grips, fixtures, load cells & other accessories for monotonic testing

Table of Contents

Description	Model	Page	Description	Model	Page
TABLE OF CONTENTS		2-3	MTS Fundamental Nut & Bolt Grips		17
INTRODUCTION TO GRIPS & FIXTURES		4-6	» 100 kN Nut & Bolt	FLA105B	17
Adapters		6-7	» 300 kN Nut & Bolt	FLA305A	17
» Standard Adapters		6	» 600 kN Nut & Bolt	FLA605B	17
» Conversion Adapters		7	MTS Fundamental Roller Grips		18
» Universal Joint	FWX105	7	» 5 kN Manual Roller	FMR503	18
Tension Grips		8-27	» 50 kN Manual Roller	CB504E	18
HYDRAULIC ACTIVATION		8-10	» 100 kN Manual Roller	FCA105C	18
Model 647 Hydraulic Wedge Grips		8	MTS Fundamental Scissor Grips		19
» 30 kN Hydraulic Wedge	647.02B	8	» 2 kN Manual Scissor	FGD203A	19
» 100 kN Hydraulic Wedge	647.10A	8	» 5 kN Manual Scissor	FGD503A	19
» 300 kN Hydraulic Wedge	647.25A	8	MTS Advantage Screw Grips		20
» 550 kN Hydraulic Wedge	647.50A	8	» 0.01 kN Manual Screw	ASG102	20
MTS Fundamental™ Hydraulic Side Grips		9	» 0.2 kN Manual Screw	ASG203	20
» 50 kN Hydraulic Single Side	FDYA504A	9	» 2 kN Manual Screw	ASG503	20
» 100 kN Hydraulic Single Side	FDYB105A	9	» 10 kN Manual Screw	ASG104	20
» FDYA504A Optional Faces	FDYA504A	9	MTS Fundamental Screw Grips		21
» FDYA105A Optional Faces	FDYA105A	9	» 1 kN Manual Screw	FDSC503B	21
MTS Fundamental Hydraulic Wedge Grips		10	» 1 kN Manual Screw	DSA103B	21
» 300 kN Hydraulic Wedge	FYD305	10	» 10 kN Manual Screw	DSA104B	21
» 600 kN Hydraulic Wedge	FYD605	10	» FDSC503B Optional Specimen Interfaces	FDSC503B	21
PNEUMATIC ACTIVATION		11-14	» DSA103B Optional Specimen Interfaces	DSA103B	21
Model 645 Pneumatic Wedge Grips		11	MTS Fundamental Shoulder Grips		22
» 2 kN Pneumatic Wedge	645.002	11	» 100 kN Shoulder	FTA105B	22
» 5 kN Pneumatic Wedge	645.005	11	» 300 kN Shoulder	FTA305B	22
» Model 645 Optional Wedges	645	11	» FTA105B Optional Specimen Interfaces	FTA105B	22
MTS Fundamental Bollard Grips		12	» FTA305B Optional Specimen Interfaces	FTA305B	22
» 0.5 kN Pneumatic Bollard	FCQA502A	12	MTS Fundamental Vise Grips		23
» 5 kN Pneumatic Bollard	FAPB503	12	» 0.1 kN Manual Vise	FDSA102A	23
MTS Advantage™ Pneumatic Vise Grips		13	» 0.5 kN Manual Vise	FDSA502B	23
» 0.01 kN Pneumatic Vise	APG101	13	» 5 kN Manual Vise	FSDS503A	23
» 0.2 kN Pneumatic Vise	APG202	13	» 0.01 kN Manual Vise	FMV101	24
» 2 kN Pneumatic Vise	APG203	13	» 0.1 kN Manual Vise	FMV102	24
» 10 kN Pneumatic Vise	APG104	13	» 0.1 kN Stainless Steel Manual Vise	BTV102	24
MTS Fundamental Pneumatic Vise Grips		14	» 20 kN Manual Vise	DSA204B	24
» 1 kN Pneumatic Vise	FDQA103B	14	» 10 kN Manual Vise	DX104A	25
» 5 kN Pneumatic Vise	FDQA503B	14	» 100 kN Manual Vise	DX105A	25
» FDQA103B Integrated Specimen Interface	FDQA103B	14	» DX104A Optional Specimen Interfaces	DX104A	25
» FDQA503B Optional Specimen Interface	FDQA503B	14	MTS Advantage Wedge Grips		26
MANUAL ACTIVATION		15-27	» 10 kN Manual Wedge	AWG104	26
MTS Fundamental Bollard Grips		15	» 30 kN Manual Wedge	AWG304	26
» 0.5 kN Manual Bollard	FCB502B	15	» 50 kN Manual Wedge	AWG504	26
» 2 kN Manual Bollard	FCH203A	15	» 100 kN Manual Wedge	AWG105	26
» 5 kN Manual Bollard	FMB503A	15	» 300 kN Manual Wedge	AWG305	26
» 5 kN Manual Bollard	FMB503B	15	MTS Fundamental Wedge Grips		27
MTS Fundamental High Force Bollard Grips		16	» 10 kN Manual Wedge	FXSA104B	27
» 10 kN Manual Bollard	FCA104B	16	» 30 kN Manual Wedge	FXSA304B	27
» 20 kN Manual Bollard	ZLD204	16	» 100 kN Manual Wedge	FXSA105A	27
» 200 kN Manual Bollard	FMB205	16	» 300 kN Manual Wedge	FXSA305A	27

Description	Model	Page
Tension Wedges		28-35
» Model 647.02B Grip Optional Wedges		28
» Model APG104 Grip Optional Wedges		28
» Model 647.10A Grip Optional Wedges		29-30
» Model 647.25A Grip Optional Wedges		31-32
» Model 647.50A Grip Optional Wedges		33
» AWG104, AWG304 & AWG504 Grip Optional Wedges		34
» AWG105 & AWG305 Grip Optional Wedges		34
» FXSA104B Grip Optional Wedges		35
» FXSA105A Grip Optional Wedges		35
» FXSA305B Grip Optional Wedges		35
Tension Faces		36-39
» FYD305 Grip Optional Faces		36
» FYD605 Grip Optional Faces		36
» APG101 Grip Optional Faces		37
» APG202 & APG203 Grip Optional Faces		37-39
» ASG102 & ASG203 Grip Optional Faces		37-39
» ASG503 & ASG104 Grip Optional Faces		39
Tension Inserts		40
» FLA105B Grip Optional Inserts		40
» FLA305B Grip Optional Inserts		40
» FLA605B Grip Optional Inserts		40
Controllers/Supply		41
» Standard Features		41
» Standalone Hydraulic Grip Supplies		41
» Model 685 Hydraulic Grip Controller/Supply		42
» MTS Advantage Pneumatic Grip Controller/Supply		43
» MTS Fundamental Pneumatic Grip Controller/Supply		43
» Grip Controller/Supply Options		43
Compression Platens		44-46
» Model 643 Compression Platens		44
» MTS Fundamental Steel Compression Platens		45
» MTS Fundamental Aluminum Compression Platens		46
» MTS Fundamental Square Compression Platens		46
Bend Fixtures		47-51
» Model 642 Three & Four Point Bend Fixtures		47-48
» Model 642 Optional Rollers		49
» MTS Fundamental Three Point Bend Fixtures		50
» MTS Fundamental Specialty Three Point Bend Fixtures		51
Specialty Fixtures		52-53
» MTS Fundamental 5 kN Puncture Fixture		52
» MTS Fundamental 90° Peel Fixture		52
» MTS Fundamental Coefficient of Friction Fixture		53

Description	Model	Page
Bionix® Accessories		54-60
TENSION		54-57
» Bionix Bollard Grips		54
» Bionix Scissor Grips		54
» Bionix Roller Grips		55
» Bionix Spring Grips		56
» Bionix Vise Grips		57
COMPRESSION		58
» Bionix Stainless Steel Compression Platens		58
FLUID BATH		59-60
» Bionix EnviroBath		59
» Fluid Bath Options		60
» Compatible Matrix		60
Composites Accessories		61-67
» Modified Celanese Compression Loading Fixture	CMP.001	61
» IITRI Compression Loading Fixture	CMP.002	61
» Combined Loading Compression (CLC) Test Fixture	CMP.003	62
» V-Notched Rail Shear Test Fixture	CMP.004	62
» V-Notched Beam (Iosipescu) Shear Fixture	CMP.005	63
» Short-Beam Strength Fixture	CMP.006	63
» CMP.006 Optional Specimen Interfaces	CMP.006.01	63
» CMP.006 Optional Specimen Interfaces	CMP.006.02	63
» Mixed Mode Bending Fixture	CMP.007	64
» Open / Filled Hole Compression Fixture	CMP.008	65
» Compression After Impact Test Fixture	CMP.009	65
» Flatwise Plane Shear Fixture, Tensile Mode	CMP.010	66
» Flatwise Plane Shear Fixture, Compression Mode	CMP.011	66
» Climbing Drum Peel Fixture with Roller Type Grips	CMP.012	67
» 3 & 4 Point Sandwich Beam Flexure / Shear Fixture	CMP.013	67
Force Transducers / Load Cells		68-70
» S-Beam Load Cells - Criterion		68
» Low Profile Bending Beam Load Cells - Criterion		68
» Low Profile Shear Beam Load Cells - Criterion		69
» S-Beam Load Cells - Exceed		70
» Low Profile Shear Beam Load Cells - Exceed		70
Tension Extensometers		71-74
» AHX850 High Elongation Extensometers		71
» LTX850 Long Travel Extensometers		72
» FAX1352 Automatic Extensometers		73
» Series 635 Monotonic Tensile Extensometers		74
Environmental Simulation		75-78
CHAMBERS		75
FURNACES		76
EXTENSION RODS – CHAMBERS		77
EXTENSION RODS – FURNACES		78
Spares Kits		79
Grips & Fixtures Index		80-82

Introduction to Grips and Test Fixtures

Grips and Fixtures for Electromechanical Systems

MTS complements its electromechanical testing lines with a comprehensive array of accessories to conduct a full spectrum of material and small component testing – from basic quality control, to complex biomedical simulations, to demanding research and development applications. This catalog includes several distinct accessory families to accommodate your specific and evolving testing needs:

MTS Advantage Accessories

Highly versatile and full-featured wedge, pneumatic, and screw action grips for demanding R&D testing of advanced composites and alloys. Ideal for the specific needs of the high-end researcher, this accessory family accommodates a very broad range

of clamping force and temperature requirements and features numerous control and grip face options. MTS stands behind the MTS Advantage family line with a three-year warranty – one of the best in the industry!



MTS Fundamental Accessories

Basic affordable grips and fixtures for standard testing of plastics, textiles, rubber, wire, rope, and more. These accessories feature a universal adapter design and optional threaded frame adapters to facilitate easy installation

onto both MTS electromechanical and servohydraulic load frame systems, as well as other electromechanical test systems. Anti-rotation features and integrated alignment pins enhance test accuracy and repeatability.



Criterion Test Systems

Introduction to Grips and Test Fixtures

Bionix Accessories

Affordable and extremely durable grips, fixtures, and platens for accurately replicating biomaterial and medical device service environments and extending the utility of Bionix electromechanical and servohydraulic test solutions. These accessories feature a universal adapter design

and optional threaded frame adapters. This facilitates easy installation onto both MTS electromechanical and servohydraulic load frame systems as well as other electromechanical test systems. Anti-rotation features and integrated alignment pins enhance test accuracy and repeatability.



Composites Accessories

Advanced lightweight composite materials are improving product design and creating sleeker and safer solutions. MTS offers a comprehensive array of accessories to fulfill a full spectrum of polymer matrix composites material testing – from basic quality

control, to demanding research and development applications. Composites tests demand greater fidelity, more detailed measurement techniques, tighter integration with computer models and the ingenuity to deal with new materials and applications.

Can't find what you need?

We offer many more grips and fixtures. Contact your local sales representative or applications engineer to find the model that meets your exact needs.



Exceed
Test Systems

Introduction to Grips and Test Fixtures

Application of Grips and Fixtures

Grips and fixtures are critical components to material testing. Testing results might be compromised if incorrect grips or fixtures are used. MTS offers a large variety of grips and fixtures and this catalog includes popular items that are compatible with specimens defined by commonly adopted testing standards such as ASTM, ISO, DN, GB, BS, JIS and more. For additional grips and fixtures or custom designs, please contact MTS sales or application engineers.

Selection of Grips and Fixtures

Four main criteria to consider when selecting grips and fixtures:

1. TEST STANDARD

Test standards define the dimensions and shape of specimens. Often, there are many different grips that can be used to address a single test standard. If you are not certain about which grip to use for your application, please contact us.

2. SPECIMEN AND TEST METHOD

Besides the dimension and shape of specimens, the surface texture is an important factor in grip selections. For tensile tests, slipping, premature damage and cracking in the grip are quite common due to incorrect grip selection. For help determining the right grip, contact your MTS application engineer.

3. ATTACHMENT KITS

The term "attachment kit" can refer to any of the hardware required to connect your grips to your system. This is an important item to remember since the attachment kits are generally sold separately.

4. STANDARD ADAPTERS

Generally grips and fixtures will be equipped with adapters of standard dimensions to be used with clevis adapters of the frames. The advantages of using standard adapters are easy installation, accurate mounting and maximum compatibility.



Electromechanical Attachment Scheme

Clevis Pin Connection	Type B	Type C (AL)	Type C (STL)	Type D	Type E	Type F	Type 20	Type 40
Max. Load Capacity	10 N (2.2 lbf)	200 N (45 lbf)	2.5 kN (562 lbf)	150 kN (33720 lbf)	300 kN (67440 lbf)	600 kN (134885 lbf)	30 kN (6740 lbf)	100 kN (22480 lbf)
Clevis Diameter (X)	12.7 mm (0.50 in)	15.9 mm (0.625 in)	15.9 mm (0.625 in)	31.7 mm (1.25 in)	60 mm (2.36 in)	90 mm (3.54 in)	20 mm (0.787 in)	40 mm (1.57 in)
Pin Diameter (Y)	4.7 mm (0.186 in)	6.4 mm (0.25 in)	6.4 mm (0.25 in)	12.7 mm (0.50 in)	28 mm (1.1 in)	40 mm (1.57 in)	10 mm (0.039 in)	18 mm (0.71 in)

Adapters

Conversion Adapters

Grips and fixtures with other standard adapters can be used on the frames with other size standard clevis adapters with a set of suitable conversion adapters.

Conversion adapters allow you to use the same grips and fixtures on both MTS Exceed and MTS Criterion load frames.



Specifications

Part Number	100-302-950	100-302-947	100-302-952	100-302-948	100-302-951	100-302-953	100-302-949	100-260-836	100-281-224
Attachment Type (m-f)	20-D	40-20	D-20	E-20	40-D	D-40	E-40	E-D	F-E
Max. Load Capacity	30 kN (6740)	30 kN (6740)	30 kN (6740)	30 kN (6740)	100 kN (22480 lbf)	100 kN (22480 lbf)	100 kN (22480 lbf)	150 kN (33720 lbf)	300 kN (67440 lbf)
A (male clevis)	Type 20	Type 40	Type D	Type E	Type 40	Type D	Type E	Type E	Type F
B (female clevis)	Type D	Type 20	Type 20	Type 20	Type D	Type 40	Type 40	Type D	Type E
C (pin to pin height)	68.5 mm (2.7 in)	58 mm (2.3 in)	72.5 mm (2.9 in)	80 mm (3.2 in)	91 mm (3.6 in)	89.5 mm (3.5 in)	90 mm (3.5 in)	97 mm (3.8 in)	160 mm (6.3 in)
Lock Nut	M24 × 1.5	M45 × 2	M35 × 1.5	M64 × 2	M45 × 2	M35 × 1.5	M64 × 2	M64 × 2	M95 × 2

Universal Joint

Universal joints are used to help maintain axial load alignment in tensile loading applications.

Specifications

Model	FWX105
Part Number	100-258-159
Grip Type	Universal Joint
Force Capacity	100 kN (22,000 lbf)
Upper Grip Weight	3.9 kg (8.6 lbs)
Temperature Rating	0° C (32° F) to 50° C (122° F)
Attachment Type	D
Grip Height	185 mm (7.3 in)
Grip Width	84 mm (3.4 in)



Universal Joint

Tension Grips

Hydraulic Activation

Model 647 Hydraulic Wedge Grips

- » Precision, high-performance hydraulic wedge grips with the built-in versatility to support a wide range of tensile applications
- » Symmetrical housing design ensures an even specimen loading across the entire face of the wedge
- » Grips clamp onto your specimen in the same position, test after test, to minimize the bending strains that can invalidate your test results
- » Lateral movement of the wedges won't change the gripping position on the specimen once the grips are activated
- » Side loading capability for easy specimen insertion
- » Adjustable pressure allows grips to be used for testing a variety of materials
- » Grips are sold in pairs
- » Wide variety of wedges (specimen interfaces) are available to meet your varied requirements
- » All specimen interfaces (wedges) are sold separately
- » Hydraulic grip controller/supply sold separately
- » **Applications:** High-precision tensile testing of metals, ceramics, composites, plastics, wood/paper products
- » *See pages 28-33 for wedge options*
- » *See pages 41-42 for grip controller options*



Specifications

Model	647.02B	647.10A	647.25A	647.50A
Part Number	056-670-901	047-080-605	047-080-905	047-595-505
Grip Type	Hydraulic Wedge	Hydraulic Wedge	Hydraulic Wedge	Hydraulic Wedge
Force Capacity	30 kN (6,740 lbf)	100 kN (22,480 lbf)	300 kN (66,440 lbf)	550 kN (123,650 lbf)
Upper Grip Weight	7 kg (15.4 lb)	30 kg (66.1 lb)	77 kg (170 lb)	148 kg (324 lb)
Temperature Rating	-40° C (-40° F) to 177° C (350° F)	-40° C (-40° F) to 177° C (350° F)	-40° C (-40° F) to 177° C (350° F)	-18° C (0° F) to 65° C (150° F)
Attachment Type	D	M27 x 2	M36 x 2	M52 x 2
Combined Upper/Lower Grip Height	396 mm (15.6 in)	390 mm (15.2 in)	490 mm (19.2 in)	620 mm (24.4 in)
Grip Width	180 mm (7.1 in)	180 mm (7.1 in)	295 mm (11.6 in)	358 mm (14.1 in)
Maximum Input Pressure	20 MPa (3,000 psi)	20 MPa (3,000 psi)	70 MPa (10,000 psi)	70 MPa (10,000 psi)

Tension Grips

Hydraulic Activation

MTS Fundamental Hydraulic Side Grips

- » Affordable hydraulic side grips that deliver constant gripping force for tensile applications
- » Side-loading, quick-acting U-shaped grips allow for easy specimen insertion
- » Stable clamping force minimizes slipping and maximizes accuracy and repeatability
- » Capable of off-center specimen tests
- » Adjustable pressure provides proper grip force for a variety of materials
- » Grips are sold in pairs
- » Wide variety of specimen interfaces are available to meet your varied differing specimen profiles, materials and surfaces
- » All specimen interfaces (“faces”) are sold separately
- » Hydraulic grip controller/supply unit is sold separately
- » **Applications:** High-force tensile testing of steel, rebar, ceramics, composites, plastics and wood/paper products
- » See pages 41-42 for grip controller options



Specifications

Model	FDYA504A	FDYB105A
Part Number	100-408-988	100-302-638
Grip Type	Hydraulic Single Side	Hydraulic Single Side
Force Capacity	50 kN (11,000 lbf)	100 kN (22,500 lbf)
Upper Grip Weight	25 kg (55.1 lb)	42 kg (92.6 lb)
Temperature Rating	0° C (32° F) to 50° C (122° F)	0° C (32° F) to 50° C (122° F)
Attachment Type	D	D
Combined Upper/Lower Grip Height	446 mm (17.6 in)	506 mm (19.9 in)
Grip Width	301 mm (11.9 in)	358 mm (14.1 in)
Maximum Input Pressure	20 MPa (3000 psi)	20 MPa (3000 psi)

FDYA504A Optional Faces

Model	Part Number	Profile	Surface	Height	Width	Temperature Range	Specimen Range
FDYA504A.03	100-302-842	Flat	Sawtooth Steel	60 mm (2.3 in)	98 mm (3.8 in)	0° C (32° F) to 50° C (122° F)	0-18 mm (0-0.7 in)
FDYA504A.04	100-302-843	Vee	Serrated Steel	60 mm (2.3 in)	98 mm (3.8 in)	0° C (32° F) to 50° C (122° F)	ø4-ø12 mm (0.2-0.5 in)
FDYA504A.05	100-302-844	Vee	Serrated Steel	60 mm (2.3 in)	98 mm (3.8 in)	0° C (32° F) to 50° C (122° F)	ø12-ø20 mm (0.5-0.8 in)

FDYB105A Optional Faces

Model	Part Number	Profile	Surface	Height	Width	Temperature Range	Specimen Range
FDYB105A.03	100-302-845	Flat	Sawtooth Steel	60 mm (2.3 in)	98 mm (3.8 in)	0° C (32° F) to 50° C (122° F)	0-28 mm (0-1.1 in)
FDYB105A.04	100-302-846	Vee	Serrated Steel	60 mm (2.3 in)	98 mm (3.8 in)	0° C (32° F) to 50° C (122° F)	ø4-ø12 mm (0.2-0.5 in)
FDYB105A.05	100-302-847	Vee	Serrated Steel	60 mm (2.3 in)	98 mm (3.8 in)	0° C (32° F) to 50° C (122° F)	ø12-ø28 mm (0.5-1.1 in)

Tension Grips

Hydraulic Activation

MTS Fundamental Hydraulic Wedge Grips

- » Affordable hydraulic wedge grips for higher force capacity tensile applications
- » Side loading capability for easy specimen insertion
- » Grips are sold in pairs
- » Wide variety of wedges (specimen interfaces) are available to meet your varied requirements
- » All specimen interfaces (wedges) are sold separately
- » Hydraulic grip controller/supply unit is sold separately
- » **Applications:** High-precision tensile testing of metals, ceramics, composites, plastics, wood/paper products
- » *See page 36 for wedge options*
- » *See pages 41-42 for grip controller options*



Specifications

Model	FYD305	FYD605
Part Number	100-336-772	100-369-052
Grip Type	Hydraulic Wedge	Hydraulic Wedge
Force Capacity	300 kN (66,440 lbf)	600 kN (134,885 lbf)
Upper Grip Weight	92.5 kg (204 lb)	165 kg (364 lb)
Temperature Rating	0° C (32° F) to 50° C (122° F)	0° C (32° F) to 50° C (122° F)
Attachment Type	E	M52 x 2
Combined Upper/Lower Grip Height	756 mm (29.8 in)	976 mm (38.4 in)
Grip Width	270 mm (10.6 in)	330 mm (13 in)
Maximum Input Pressure	20 MPa (3,000 psi)	20 MPa (3,000 psi)

Tension Grips

Pneumatic Activation

Model 645 Pneumatic Wedge Grips

- » High-performance, reliable pneumatic wedge grips with the built-in versatility to support a wide range of tensile applications
- » Symmetrical housing design ensures an even specimen loading across the entire face of the wedge
- » Grips clamp onto your specimen in the same position, test after test, to minimize the bending strains that can invalidate your test results
- » Lateral movement of the wedges won't change the gripping position on the specimen once the grips are activated
- » Side loading capability for easy specimen insertion
- » Adjustable pressure allows grips to be used for testing a variety of materials
- » Grips are sold in pairs
- » Wide variety of wedges (specimen interfaces) are available to meet your varied requirements
- » All specimen interfaces (wedges) are sold separately
- » Operation requires a dry, filtered air supply sold separately
- » Pneumatic gripping controller is sold separately
- » **Applications:** Tensile testing of metals, ceramics, composites, plastics, wood/paper products
- » *See page 43 for grip controller options*

Specifications

Model	645.002	645.005
Part Number	100-242-422	100-242-417
Grip Type	Pneumatic Wedge	Pneumatic Wedge
Force Capacity	2 kN (0.44kip)	5 kN (1.1 kip)
Upper Grip Weight	1.76 kg (3.9 lb)	2.81 kg (6.2 lb)
Temperature Rating	-40° C (-40° F) to 200° C (400° F)	-40° C (-40° F) to 200° C (400° F)
Attachment Type	D	D
Combined Upper/Lower Grip Height	369.8 mm (14.5 in)	375.4 mm (14.8 in)
Grip Width	104 mm (4.1 in)	147 mm (5.8 in)
Maximum Input Pressure	0.55 MPa (80 PSI)	0.55 MPa (80 PSI)
Compatible Grip Controller Type	MTS Fundamental Dual Acting Pneumatic Grip Controller/Supply	MTS Fundamental Dual Acting Pneumatic Grip Controller/Supply



Model 645 Optional Wedges

Model	Part Number	Profile	Surface	Height	Width	Temperature Range	Specimen Range	Compatible Grip(s)
645.005.01	050-507-938	Flat	Sawtooth Steel	38 mm (1.5 in)	25 mm (1.0 in)	-40° C (-40° F) to 177° C (350° F)	0-7.2 mm (0-0.28 in)	645.002, 645.005
645.005.02	050-507-939	Flat	Sawtooth Steel	38 mm (1.5 in)	25 mm (1.0 in)	-40° C (-40° F) to 177° C (350° F)	3.3-10.6 mm (0.13-0.42 in)	645.002, 645.005
645.005.03	050-507-940	Flat	Sawtooth Steel	38 mm (1.5 in)	25 mm (1.0 in)	-40° C (-40° F) to 177° C (350° F)	5.4-12.4 mm (0.21-0.49 in)	645.002, 645.005
645.005.04	050-507-941	Flat	Surfallooy	38 mm (1.5 in)	25 mm (1.0 in)	-40° C (-40° F) to 177° C (350° F)	0-7.2 mm (0-0.28 in)	645.002, 645.005
645.005.05	050-507-942	Flat	Surfallooy	38 mm (1.5 in)	25 mm (1.0 in)	-40° C (-40° F) to 177° C (350° F)	3.3-10.6 mm (0.13-0.42 in)	645.002, 645.005
645.005.06	050-507-943	Flat	Surfallooy	38 mm (1.5 in)	25 mm (1.0 in)	-40° C (-40° F) to 177° C (350° F)	5.4-12.4 mm (0.21-0.49 in)	645.002, 645.005
645.005.07	050-507-944	Vee	Diamond Tip Steel	38 mm (1.5 in)	25 mm (1.0 in)	-40° C (-40° F) to 177° C (350° F)	ø3-7.8 mm (0.12-0.31 in) Side, ø9.4 mm (0.37 in) Top	645.002, 645.005
645.005.08	050-507-945	Vee	Diamond Tip Steel	38 mm (1.5 in)	25 mm (1.0 in)	-40° C (-40° F) to 177° C (350° F)	ø7.1-7.8 mm (0.28-0.31 in) Side, ø12.7 mm (0.50 in) Top	645.002, 645.005
645.005.09	050-507-946	Vee	Diamond Tip Steel	38 mm (1.5 in)	25 mm (1.0 in)	-40° C (-40° F) to 177° C (350° F)	ø10.9-13.2 mm (0.43-0.52 in) Side, ø16.5 mm (0.65 in) Top	645.002, 645.005

Tension Grips

Pneumatic Activation

MTS Fundamental Bollard Grips

- » Affordable pneumatic gripping mechanism minimizes specimen slippage
- » “Horn” style design reduces stress concentration on specimens and avoids grip-induced failures.
- » Adjustable pressure allows clamping forces to be used for testing a variety of materials
- » Grips are sold in pairs
- » Specimen interface (“face”) is integrated with each grip
- » Operation requires a dry, filtered air supply sold separately
- » Pneumatic gripping controller sold separately
- » **Applications:** Tensile testing of cords, filaments, fibers, fine wire, yarns
- » *See page 43 for grip controller options*



Specifications

Model	FCQA502A	FPB503
Part Number	100-231-830	100-139-065
Grip Type	Pneumatic Bollard	Pneumatic Bollard
Force Capacity	0.5 kN (112 lbf)	5 kN (1,125 lbf)
Upper Grip Weight	1.12 kg (2.4 lb)	2 kg (4.4 lbs)
Temperature Rating	0° C (32° F) to 50° C (122° F)	-40° C (-40° F) to 80° C (176° F)
Attachment Type	D	D
Combined Upper/Lower Grip Height	326 mm (12.8 in)	410 mm (16 in)
Grip Width	154 mm (6.0 in)	198 mm (7.8 in)
Maximum Input Pressure	0.55 MPa (80 PSI)	0.55 MPa (80 PSI)
Compatible Grip Controller Type	MTS Fundamental Dual Acting Pneumatic Grip Controller/Supply	MTS Advantage Single Acting Pneumatic Grip Controller/Supply

Integrated Specimen Interface

Profile	Flat	Flat
Surface	Smooth Steel	Smooth Steel
Minimum Length	300 mm (11.8 in)	255 mm (10 in)
Specimen Range	0-1.5 mm (0-0.04 in)	ø0-5 mm (ø0-0.2 in)

Tension Grips

Pneumatic Activation

MTS Advantage Pneumatic Vise Grips

- » Versatile, high-performance pneumatic vise grips designed for a wide range of tensile applications
- » Designed and machined to precise tolerances, eliminating side loads
- » Lightweight to perform low force tests while minimizing your low-capacity load cells capacity
- » Dual-acting grip faces simultaneously move to the centerline of the grip to ensure correct specimen alignment and eliminate bending strains
- » Grips are sold in pairs
- » All specimen interfaces (“faces”) are sold separately
- » Operation requires a dry, filtered air supply sold separately
- » Pneumatic gripping controller sold separately
- » **Applications:** Tensile testing of low-breaking-strength specimens, thin sheets, films, tapes, elastomers, plastics, rigid and semi-rigid films and sheets
- » See pages 28, 37, 38, 39 for face options
- » See page 43 for grip controller options



Specifications

Model	APG101	APG202	APG203	APG104
Part Number	100-032-017	100-036-576	100-280-342	100-034-623
Grip Type	Pneumatic Vise	Pneumatic Vise	Pneumatic Vise	Pneumatic Wedge
Force Capacity	0.01 kN (2.25 lbf)	0.2 kN (45 lbf)	2 kN (450 lbf)	10 kN (2200 lbf)
Upper Grip Weight	0.27 kg (0.6 lb)	1 kg (2.2 lb)	3.2 kg (7.0 lb)	6.8 kg (15 lb)
Temperature Rating	-40° C (-40° F) to 200° C (400° F)	-40° C (-40° F) to 200° C (400° F)	-40° C (-40° F) to 200° C (400° F)	-40° C (-40° F) to 200° C (400° F)
Attachment Type	B	C	D	D
Combined Upper/Lower Grip Height	326 mm (12.8 in)	360 mm (14.2 in)	454 mm (17.8 in)	396 mm (15.6 in)
Grip Width	71 mm (2.8 in)	114 mm (4.5 in)	147 mm (5.8 in)	210 mm (8.3 in)
Maximum Input Pressure	0.55 MPa (80 PSI)	0.55 MPa (80 PSI)	0.55 MPa (80 PSI)	0.55 MPa (80 PSI)
Compatible Grip Controller Type	MTS Advantage Single Acting Pneumatic Grip Controller/Supply	MTS Advantage Single Acting Pneumatic Grip Controller/Supply	MTS Advantage Single Acting Pneumatic Grip Controller/Supply	MTS Advantage Single Acting Pneumatic Grip Controller/Supply

Tension Grips

Pneumatic Activation

MTS Fundamental Pneumatic Vise Grips

- » Affordable pneumatic vise grips designed for a wide range of tensile applications
- » Anti-rotation features and integrated alignment pins enhance test accuracy and repeatability
- » Grips are sold in pairs
- » Operation requires a dry, filtered air supply sold separately
- » Pneumatic gripping controller sold separately
- » **Applications:** Tensile testing of paper, plastic film, textiles, sheet materials and packaging components
- » See page 43 for grip controller options

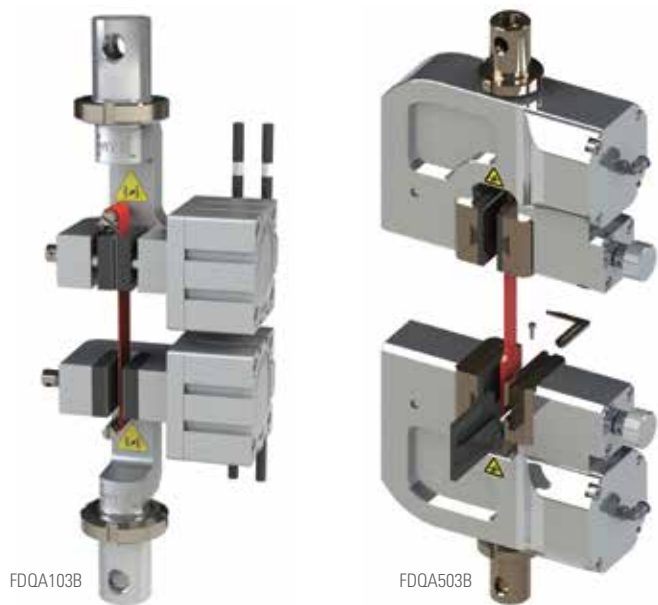

Specifications

Model	FDQA103B	FDQA503B
Part Number	100-231-831	100-279-862
Grip Type	Pneumatic Vise	Pneumatic Vise
Force Capacity	1 kN (225 lbf)	5 kN (1,125 lbf)
Upper Grip Weight	1.26 kg (2.7 lb)	5.48 kg (12.1 lb)
Temperature Rating	0° C (32° F) to 50° C (122° F)	0° C (32° F) to 50° C (122° F)
Attachment Type	D	D
Combined Upper/Lower Grip Height	330 mm (13 in)	430 mm (16.9 in)
Grip Width	130 mm (5.1 in)	231 mm (9.1 in)
Maximum Input Pressure	0.55 MPa (80 PSI)	0.55 MPa (80 PSI)
Compatible Grip Controller Type	MTS Fundamental Dual Acting Pneumatic Grip Controller/Supply	MTS Advantage Single Acting Pneumatic Grip Controller/Supply

FDQA103B Integrated Specimen Interface

Profile	Flat
Surface	Rubber
Height	30 mm (1.2 in)
Width	35 mm (1.4 in)
Specimen Range	0-8 mm (0-0.3 in)

FDQA503B Optional Specimen Interfaces

Model	Part Number	Profile	Surface	Height	Width	Temperature Range	Specimen Range
FDQA503B.01	100-281-153	Flat	Rubber	50 mm (2 in)	60 mm (2.4 in)	0° C (32° F) to 50° C (122° F)	0-14 mm (0-0.55 in)
FDQA503B.02	100-281-154	Flat	Sawtooth	50 mm (2 in)	60 mm (2.4 in)	0° C (32° F) to 50° C (122° F)	0-14 mm (0-0.55 in)

Tension Grips

Manual Activation

MTS Fundamental Bollard Grips

- » Affordable grips designed to reduce stress concentration on specimens and avoid grip-induced failures
- » Anti-rotation features and integrated alignment pins enhance test accuracy and repeatability
- » Grips are sold in pairs
- » Specimen interface (“face”) is integrated with each grip
- » **Applications:** Tensile tests of cords, filaments, fibers, fine wire and yarn



Specifications

Model	FCB502B	FCH203A	FMB503A	FMB503B
Part Number	100-231-828	100-231-829	100-034-764	100-034-765
Grip Type	Manual Bollard	Manual Bollard	Manual Bollard	Manual Bollard
Force Capacity	0.5 kN (112 lbf)	2 kN (450 lbf)	5 kN (1,125 lbf)	5 kN (1,125 lbf)
Upper Grip Weight	0.91 kg (2.0 lb)	1.07 kg (2.4 lb)	0.84 kg (1.8 lbs)	1.1 kg (2.4 lbs)
Temperature Rating	0° C (32° F) to 50° C (122° F)	0° C (32° F) to 50° C (122° F)	-40° C (-40° F) to 200° C (392° F)	-40° C (-40° F) to 200° C (392° F)
Attachment Type	D	D	D	D
Combined Upper/Lower Grip Height	280 mm (11 in)	316 mm (12.4 in)	310 mm (12.2 in)	368 mm (14.4 in)
Grip Width	114.4 mm (2.3 in)	177 mm (7.0 in)	108 mm (4.2 in)	134 mm (5.3 in)

Integrated Specimen Interface

Profile	Flat	Flat	Flat	Flat
Surface	Smooth Steel	Smooth Steel	Sawtooth Steel	Sawtooth Steel
Minimum Length	190 mm (7.5 in)	250 mm (4.8 in)	300 mm (11.8 in)	450 mm (17.7 in)
Specimen Range	ø0-1.5 mm (ø0-0.04 in)	ø0-1.5 mm (ø0-0.04 in)	ø0-4 mm (ø0-0.16 in)	ø0-6 mm (ø0-0.23 in)

Tension Grips

Manual Activation

MTS Fundamental High Force Bollard Grips

- » Affordable grips designed to reduce stress concentration on specimens and avoid grip-induced failures
- » Anti-rotation features and integrated alignment pins enhance test accuracy and repeatability
- » Grips are sold in pairs
- » Specimen interface ("face") is integrated with each grip
- » **Applications:** Higher force tensile tests of cords, filaments, fibers, fine wire, and yarn



FCA104B

Specifications

Model	FCA104B	ZLD204	FMB205
Part Number	100-258-157	100-302-722	100-409-047
Grip Type	Manual Bollard	Manual Bollard	Manual Bollard
Force Capacity	10 kN (2,250 lbf)	20 kN (4,500 lbf)	200 kN (45,000 lbf)
Upper Grip Weight	2.2 kg (4.8 lb)	2.07 kg (4.6 lb)	21.5 kg (47.4 lb)
Temperature Rating	0° C (32° F) to 50° C (122° F)	0° C (32° F) to 50° C (122° F)	0° C (32° F) to 50° C (122° F)
Attachment Type	D	20	E
Combined Upper/Lower Grip Height	430 mm (16.9 in)	514 mm (20.2 in)	740 mm (29.1 in)
Grip Width	166 mm (6.5 in)	55 mm (2.2 in)	281 mm (11 in)

Integrated Specimen Interface

Profile	Flat	Flat	Flat
Surface	Sawtooth Steel	Smooth Steel	Smooth Steel
Minimum Length	650 mm (25.6 in)	1040 mm (41 in)	3500 mm (137 in)
Specimen Range	ø0-2 mm (ø0-0.08 in)	ø0-15 mm (ø0-0.2 in)	ø8-12 mm (ø0.31-0.47 in)

Tension Grips

Manual Activation

MTS Fundamental Nut & Bolt Grips

- » Affordable nut and bolt grips that enable tension, proof load and wedge load tests
- » Accommodates two types of loading plates and a selection of inserts for testing bolts on a wide range of thread configurations and a wide range of nut configurations
- » Anti-rotation features and integrated alignment pins enhance test accuracy and repeatability
- » Grips are sold in pairs
- » All specimen interfaces (inserts) are sold separately
- » **Applications:** Tensile, proof load and wedge load tests of bolts, screws, studs, nuts, washers, and rivets
- » See page 40 for insert options



Specifications

Model	FLA105B	FLA305A	FLA605B
Part Number	100-258-716	100-637-668	100-532-788
Grip Type	Nut & Bolt	Nut & Bolt	Nut & Bolt
Force Capacity	100 kN (22,480 lbf)	300 kN (67,440 lbf)	600 kN (134,885 lbf)
Upper Grip Weight	4.1 kg (9.0 lb)	20 kg (44.1 lb)	16.9 kg (37.3 lb)
Temperature Rating	0° C (32° F) to 50° C (122° F)	0° C (32° F) to 50° C (122° F)	0° C (32° F) to 50° C (122° F)
Attachment Type	D	E	38 mm post
Combined Upper/Lower Grip Height	314 mm (12.3 in)	516 mm (20.3 in)	540 mm (21.2 in)
Grip Width	134 mm (5.3 in)	187 mm (7.4 in)	205 mm (8 in)

Tension Grips

Manual Activation

MTS Fundamental Roller Grips

- » Affordable roller grips designed for quick loading and self-tightening
- » Anti-rotation features and integrated alignment pins enhance test accuracy and repeatability
- » Wound up specimen clamping prevents stress concentration and damage outside of test range
- » Clamping force may be increased by winding the specimen around the movable part of the grip
- » Grips are sold in pairs
- » Specimen interface (“drum”) is integrated with each grip
- » **Applications:** Tensile tests of bandages, textiles, synthetics, and flexible polymers



FMR503



CB504E



FCA105C

Specifications

Model	FMR503	CB504E	FCA105C
Part Number	100-033-790	100-302-702	100-257-526
Grip Type	Manual Roller	Manual Roller	Manual Roller
Force Capacity	5 kN (1,125 lbf)	50 kN (11,250 lbf)	100 kN (22,000 lbf)
Upper Grip Weight	0.74 kg (1.6 lbs)	8.34 kg (18.4 lb)	8.34 kg (18.4 lb)
Temperature Range	-15° C (5° F) to 50° C (122° F)	0° C (32° F) to 50° C (122° F)	-50° C (-58° F) to 150° C (302° F)
Attachment Type	D	40	D
Combined Upper/Lower Grip Height	266 mm (10.5 in)	410 mm (16.1 in)	534 mm (21 in)
Grip Width	89 mm (3.5 in)	182 mm (7.2 in)	138 mm (5.4 in)

Integrated Specimen Interface

Profile	Self-Tightening Full-Round	Self-Tightening Half-Round	Self-Tightening Full-Round
Surface	Diamond Steel	Smooth Steel	Smooth Steel
Minimum Length	400 mm (15.7 in)	650 mm (25.6 in)	650 mm (25.6 in)
Specimen Range	0-7.5 mm (0-0.3 in)	0-4 mm (0-0.2 in)	0-5 mm (0-0.2 in)
Maximum Width	30 mm (1.2 in)	100 mm (3.9 in)	85 mm (3.3 in)

Tension Grips

Manual Activation

MTS Fundamental Scissor Grips

- » Affordable scissor grips that feature self-tightening, self-aligning clamps
- » Anti-rotation features and integrated alignment pins enhance test accuracy and repeatability
- » Grips are sold in pairs
- » Specimen interface (“face”) is integrated with each grip
- » **Applications:** Tensile testing of delicate flat, flexible specimens like foil, films, rubber, and flexible polymers



Specifications

Model	FGD203A	FGD503A
Part Number	100-231-401	100-231-402
Grip Type	Manual Scissors	Manual Scissors
Force Capacity	2 kN (450 lbf)	5 kN (1,124 lbf)
Upper Grip Weight	1.01 kg (2.2 lb)	1.74 kg (3.8 lb)
Temperature Rating	0° C (32° F) to 50° C (122° F)	0° C (32° F) to 50° C (122° F)
Attachment Type	D	D
Combined Upper/Lower Grip Height	298 mm (11.7 in)	346 mm (13.6 in)
Grip Width	164 mm (6.5 in)	194 mm (7.6 in)

Integrated Specimen Interface

Profile	Flat	Flat
Surface	Sawtooth Steel	Sawtooth Steel
Height	16 mm (0.6 in)	25 mm (1.0 in)
Width	30 mm (1.2 in)	40 mm (1.6 in)
Specimen Range	0-12 mm (0-0.5 in)	0-14 mm (0-0.6 in)

Tension Grips

Manual Activation

MTS Advantage Screw Grips

- » High-performance, versatile screw grips with approximately twice the clamp force of comparably rated pneumatic grips
- » Dual-acting grip faces ensure correct specimen alignment and eliminate bending strains
- » Alignment guide assures concentricity
- » Faces pivot for self-alignment and reduced likelihood of breakage at the specimen face contact
- » Quick and easy interchangeable faces are compatible with MTS pneumatic grips
- » Flexible mounting allows adapters to be easily changed
- » Accommodates threaded configurations
- » Knurled screw for hand tightening of specimen during installation
- » Low profile grip body increases test space, provides room to hold flexible specimens above and below the faces
- » Side-loading design suitable for use in environmental chambers
- » Can be used in a fixed (one side follows through) and non-fixed (both sides follow through) configuration
- » Interchangeable, resilient pucks to allow follow through action, to compensate for specimen neck-down, minimize damage to delicate specimens, and increase clamp load for difficult specimens
- » Temperature range of -129°C to 200°C (-200°F to 400°F) when using the aluminum version of the pucks described above.
- » Grips are sold in pairs
- » All specimen interfaces (“faces”) are sold separately
- » **Applications:** Tensile testing of metals, plastics, polymers, and wood with ability to test lap shear specimens
- » *See pages 37-39 for wedge options*



Specifications

Model	ASG102	ASG203	ASG503	ASG104
Part Number	055-426-701	055-426-801	055-426-901	100-030-185
Grip Type	Manual Screw	Manual Screw	Manual Screw	Manual Screw
Force Capacity	0.01 kN (2.25 lbf)	0.2 kN (45 lbf)	2 kN (450 lbf)	10 kN (2,250 lbf)
Upper Grip Weight	0.27 kg (0.6 lb)	1 kg (2.2 lb)	3.2 kg (7.0 lb)	6.8 kg (15.0 lb)
Temperature Rating	-40° C (-40° F) to 200° C (400° F)	-40° C (-40° F) to 200° C (400° F)	-40° C (-40° F) to 200° C (400° F)	-40° C (-40° F) to 200° C (400° F)
Attachment Type	C	D	D	D
Combined Upper/Lower Grip Height	236 mm (9.3 in)	294 mm (11.6 in)	350 mm (13.8 in)	352 mm (13.9 in)
Grip Width	130 mm (5.1 in)	164 mm (6.5 in)	211 mm (8.3 in)	210.6 mm (8.29 in)

Tension Grips

Manual Activation

MTS Fundamental Screw Grips

- » Affordable screw grips that deliver higher clamping forces than vise grips
- » Improved applications performance with manual side face adjustment and adjustable clamping position inside the grip
- » Quick-acting U-shaped grips allow specimen loading from the side for better test performance
- » Centering device provides fast and accurate specimen center force axis positioning
- » Grips are sold in pairs
- » All specimen interfaces (“faces”) are sold separately
- » **Applications:** Tensile testing of stronger, larger paper, plastic plate and film, textiles, sheet materials and packaging specimens

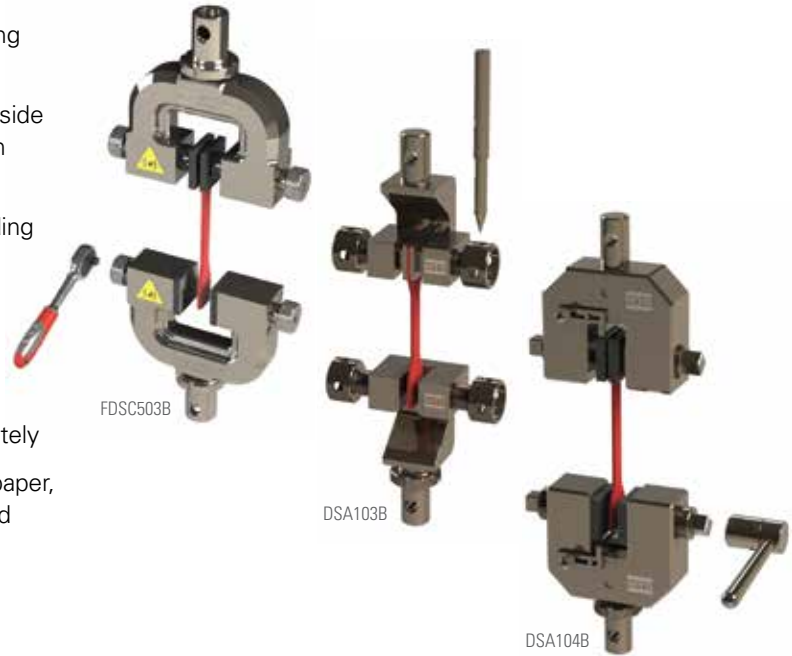

Specifications

Model	FDSC503B	DSA103B	DSA104B
Part Number	100-238-152	100-302-669	100-302-671
Grip Type	Manual Screw	Manual Screw	Manual Screw
Force Capacity	1 kN (225 lbf)	1 kN (225 lbf)	10 kN (2,250 lbf)
Upper Grip Weight	2.36 kg (5.2 lb)	0.08 kg (1.8 lb)	1.90 kg (4.2 lb)
Temperature Rating	0° C (32° F) to 50° C (122° F)	0° C (32° F) to 50° C (122° F)	0° C (32° F) to 50° C (122° F)
Attachment Type	D	20	20
Combined Upper/Lower Grip Height	298 mm (11.7 in)	201 mm (7.9 in)	234 mm (9.2 in)
Grip Width	172 mm (6.8 in)	106 mm (4.2 in)	123 mm (4.8 in)

FDSC503B Optional Specimen Interfaces

Model	Part Number	Profile	Surface	Height	Width	Temperature Range	Specimen Range
FDSC503B.01	100-238-153	Flat	Sawtooth Steel	36 mm (1.4 in)	36 mm (1.4 in)	0° C (32° F) to 50° C (122° F)	0-16 mm (0-0.6 in)
FDSC503B.02	100-238-164	Flat	Rubber	36 mm (1.4 in)	36 mm (1.4 in)	0° C (32° F) to 50° C (122° F)	0-16 mm (0-0.6 in)

DSA103B Optional Specimen Interfaces

DSA103B-02	100-311-702	Flat	Smooth Steel	24 mm (0.9 in)	26 mm (1 in)	0° C (32° F) to 50° C (122° F)	0-12 mm (0-0.5 in)
DSA103B-02A	100-311-703	Flat	Sawtooth Steel	24 mm (0.9 in)	26 mm (1 in)	0° C (32° F) to 50° C (122° F)	0-12 mm (0-0.5 in)

DSA104B Optional Specimen Interfaces

DSA104B-09/11	100-311-704	Flat	Sawtooth Steel	30 mm (1.1 in)	34 mm (1.3 in)	0° C (32° F) to 50° C (122° F)	0-14 mm (0-0.6 in)
DSA104B-10	100-311-705	Flat	Corrugated (R8) Steel	70 mm (2.7 in)	32 mm (1.2 in)	0° C (32° F) to 50° C (122° F)	0-13 mm (0-0.5 in)
DSA104B-12	100-311-706	Flat	Corrugated (R5) Steel	70 mm (2.7 in)	32 mm (1.2 in)	0° C (32° F) to 50° C (122° F)	0-12 mm (0-0.5 in)

Tension Grips

Manual Activation

MTS Fundamental Shoulder Grips

- » Affordable high force grips for shoulder-ended metal parts
- » Anti-rotation features and integrated alignment pins enhance test accuracy and repeatability
- » Grips are sold in pairs
- » All specimen interfaces (inserts) are sold separately
- » **Applications:** Tensile tests metal materials where the sample rests on a shoulder ledge

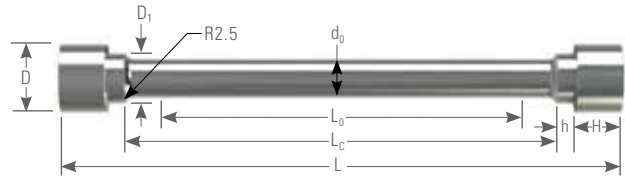

FTA105B

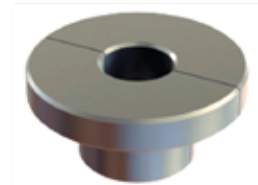
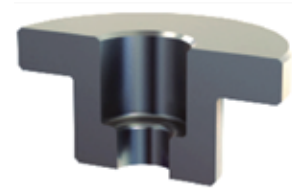

Example of Optional Interface

Specifications

Model	FTA105B	FTA305B
Part Number	100-258-715	100-296-160
Grip Type	Shoulder	Shoulder
Force Capacity	100 kN (22,480 lbf)	300 kN (67,440 lbf)
Upper Grip Weight	4.5kg (9.9 lb)	26.0 kg (57.3 lb)
Temperature Rating	0° C (32° F) to 50° C (122° F)	0° C (32° F) to 50° C (122° F)
Attachment Type	D	E
Combined Upper/Lower Grip Height	330 mm (13 in)	526 mm (20.7 in)
Grip Width	146 mm (5.7 in)	219 mm (8.6 in)

Specimen Size

Shoulder	d ₀	D ₁	D	h	H	L ₀	L _c	L
FTA105B.01	3 mm (0.118 in)	4 mm (0.157 in)	6 mm (0.236 in)	6 mm (0.236 in)	5 mm (0.197 in)	50 mm (1.969 in)	53 mm (2.087 in)	78 mm (3.071 in)
FTA105B.02	5 mm (0.197 in)	7 mm (0.276 in)	12 mm (0.472 in)	6.5 mm (0.256 in)	8 mm (0.315 in)	50 mm (1.969 in)	55 mm (2.165 in)	88 mm (3.465 in)
FTA105B.03	6 mm (0.236 in)	8 mm (0.315 in)	13 mm (0.512 in)	7 mm (0.276 in)	10 mm (0.394 in)	50 mm (1.969 in)	56 mm (2.205 in)	94 mm (3.701 in)
FTA105B.04	8 mm (0.315 in)	10 mm (0.394 in)	15 mm (0.591 in)	8 mm (0.315 in)	10 mm (0.394 in)	50 mm (1.969 in)	58 mm (2.283 in)	98 mm (3.858 in)
FTA105B.05	10 mm (0.394 in)	13 mm (0.512 in)	18 mm (0.709 in)	12 mm (0.472 in)	12 mm (0.472 in)	50 mm (1.969 in)	60 mm (2.362 in)	113 mm (4.449 in)

Shoulder	d ₀	D ₁	D	h	H	L ₀	L _c	L
FTA305B.01	10 mm (0.394 in)	13 mm (0.512 in)	18 mm (0.709 in)	14 mm (0.551 in)	12 mm (0.472 in)	50 mm (1.969 in)	60 mm (2.362 in)	113 mm (4.449 in)
FTA305B.02	12.5 mm (0.492 in)	16 mm (0.827 in)	22 mm (0.866 in)	20 mm (0.787 in)	15 mm (0.591 in)	60 mm (2.362 in)	78 mm (3.071 in)	148 mm (5.827 in)
FTA305B.03	16 mm (0.630 in)	21 mm (0.827 in)	28 mm (1.102 in)	30 mm (1.181 in)	19 mm (0.748 in)	80 mm (3.150 in)	96 mm (3.779 in)	194 mm (7.638 in)
FTA305B.04	20 mm (0.787 in)	26 mm (1.024 in)	35 mm (1.378 in)	46 mm (1.811 in)	24 mm (0.945 in)	100 mm (3.937 in)	120 mm (4.724 in)	260 mm (10.236 in)
FTA305B.05	25 mm (0.984 in)	32 mm (1.260 in)	45 mm (1.772 in)	48 mm (1.890 in)	30 mm (1.181 in)	125 mm (4.921 in)	150 mm (5.906 in)	306 mm (12.047 in)

FTA105B Optional Specimen Interfaces

Model	Part Number	Profile	Temperature Range	Specimen Range	Compatible Grip Model
FTA105B.01	100-258-729	Shoulder	0° C (32° F) to 50° C (122° F)	ø3 mm	FTA105B
FTA105B.02	100-258-730	Shoulder	0° C (32° F) to 50° C (122° F)	ø5 mm	FTA105B
FTA105B.03	100-258-731	Shoulder	0° C (32° F) to 50° C (122° F)	ø6 mm	FTA105B
FTA105B.04	100-258-732	Shoulder	0° C (32° F) to 50° C (122° F)	ø8 mm	FTA105B
FTA105B.05	100-258-733	Shoulder	0° C (32° F) to 50° C (122° F)	ø10 mm	FTA105B

FTA305B Optional Specimen Interfaces

Model	Part Number	Profile	Temperature Range	Specimen Range	Compatible Grip Model
FTA305B.01	100-339-726	Shoulder	0° C (32° F) to 50° C (122° F)	ø10 mm	FTA305B
FTA305B.02	100-296-161	Shoulder	0° C (32° F) to 50° C (122° F)	ø12.5 mm	FTA305B
FTA305B.03	100-339-727	Shoulder	0° C (32° F) to 50° C (122° F)	ø16 mm	FTA305B
FTA305B.04	100-339-728	Shoulder	0° C (32° F) to 50° C (122° F)	ø20 mm	FTA305B
FTA305B.05	100-339-729	Shoulder	0° C (32° F) to 50° C (122° F)	ø25 mm	FTA305B

Tension Grips

Manual Activation

MTS Fundamental Vise Grips

- » Affordable vise grips
- » Anti-rotation features and integrated alignment pins enhance test accuracy and repeatability
- » Grips are sold in pairs
- » Specimen interface (“face”) is integrated with each grip
- » **Applications:** Tensile testing of paper, plastic film, textiles, sheet materials and packaging components

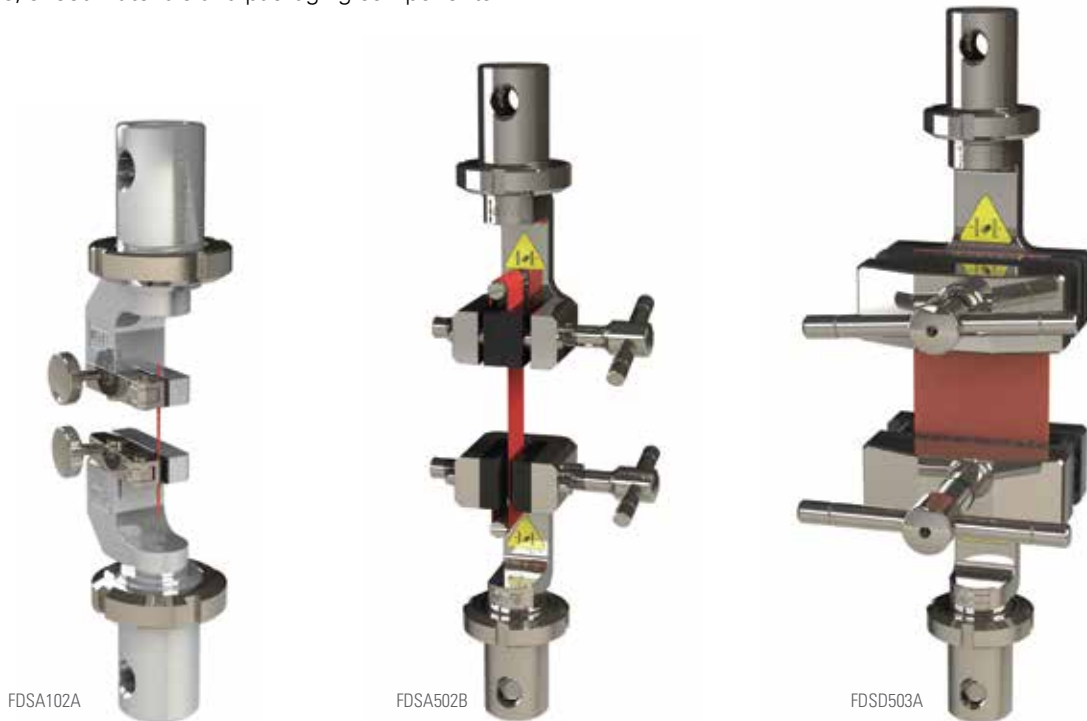

Specifications

Model	FDSA102A	FDSA502B	FDSD503A
Part Number	100-231-832	100-231-833	100-231-400
Grip Type	Manual Vise	Manual Vise	Manual Vise
Force Capacity	0.1 kN (22 lbf)	0.5 kN (112 lbf)	5 kN (1,124 lbf)
Upper Grip Weight	0.31 kg (0.7 lb)	1.0 kg (2.2 lb)	2.01 kg (4.4 lb)
Temperature Rating	0° C (32° F) to 50° C (122° F)	0° C (32° F) to 50° C (122° F)	0° C (32° F) to 50° C (122° F)
Attachment Type	D	D	D
Combined Upper/Lower Grip Height	216 mm (8.5 in)	270 mm (10.6 in)	290 mm (11.4 in)
Grip Width	71.5 mm (2.8 in)	111 mm (4.4 in)	120 mm (4.7 in)

Integrated Specimen Interface

Profile	Flat	Flat	Corrugated
Surface	Rubber	Rubber	Steel
Height	10 mm (0.4 in)	25 mm (1.0 in)	35 mm (1.4 in)
Width	10 mm (0.4 in)	35 mm (1.4 in)	65 mm (2.5 in)
Specimen Range	0-1.5 mm (0-0.04 in)	0-6 mm (0-0.2 in)	0-7 mm (0-0.03 in)

Tension Grips

Manual Activation

MTS Fundamental Vise Grips

- » Affordable vise grips for lower force testing needs
- » Anti-rotation features and integrated alignment pins enhance test accuracy and repeatability
- » Grips are sold in pairs
- » Specimen interface (“face”) is integrated with each grip
- » **Applications:** Tensile testing of paper, plastic film, textiles, sheet materials and packaging components



Specifications

Model	FMV101	FMV102	BTV102
Part Number	100-033-784	100-033-242	100-167-987
Grip Type	Manual Vise	Manual Vise	Stainless Steel Manual Vise
Force Capacity	0.01 kN (2.25 lbf)	0.1 kN (22.5 lbf)	0.1 kN (22.5 lbf)
Upper Grip Weight	0.07 kg (0.15 lbs)	0.11 kg (0.25 lbs)	0.14 kg (0.3 lbs)
Temperature Rating	-20° C (-4° F) to 70° C (158° F)	-130° C (-202° F) to 177° C (350° F)	-130° C (-202° F) to 250° C (482° F)
Attachment Type	B	C	C
Combined Upper/Lower Grip Height	158 mm (6.2 in)	161 mm (6.3 in)	161 mm (6.3 in)
Grip Width	36 mm (1.4 in)	36 mm (1.4 in)	36 mm (1.4 in)

Integrated Specimen Interface

Profile	Flat	Flat	Flat
Surface	Sawtooth Steel	Sawtooth Steel	Sawtooth Steel
Specimen Range	0-3.5 mm (0-0.14 in)	0-3 mm (0-0.12 in)	0-3 mm (0-0.12 in)
Maximum Width	20 mm (0.79 in)	14 mm (0.55 in)	14 mm (0.55 in)

MTS Fundamental Vise Grip

- » Affordable vise grips for wide specimen testing
- » Specimen reference line enables better specimen positioning
- » Grips are sold in pairs
- » Specimen interface (“face”) is integrated with each grip
- » **Applications:** Tensile testing of wide specimens including paper, plastic film, and textile materials



Specifications

Model	DSA204B
Part Number	100-302-673
Grip Type	Manual Vise
Force Capacity	20 kN (4,500 lbf)
Upper Grip Weight	15.61 kg (34.4 lb)
Temperature Range	0° C (32° F) to 50° C (122° F)
Attachment Type	20
Combined Upper/Lower Grip Height	313 mm (12.3 in)
Grip Width	210 mm (8.3 in)

Integrated Specimen Interface

Profile	Flat
Surface	Corrugated Steel
Height	50 mm (1.9 in)
Width	210 mm (8.3 in)
Specimen Range	0-10 mm (0-0.4 in)

Tension Grips

Manual Activation

MTS Fundamental Vise Grips

- » Affordable vise grips for higher force testing needs
- » Switching structure allows faces to be moved synchronously or separately
- » Quick-acting U-shaped grips allow specimen loading from the side for better test performance
- » Centering device provides fast and accurate specimen center force axis positioning
- » Grips are sold in pairs
- » All specimen interfaces (“faces”) are sold separately
- » **Applications:** Tensile testing of paper, plastic film, textiles, sheet materials and packaging components



Specifications

Model	DX104A	DX105A
Part Number	100-302-665	100-302-666
Grip Type	Manual Vise	Manual Vise
Force Capacity	10 kN (2,250 lbf)	100 kN (22,000 lbf)
Upper Grip Weight	9.80 kg (21.6 lb)	62 kg (136.7 lb)
Temperature Rating	0° C (32° F) to 50° C (122° F)	0° C (32° F) to 50° C (122° F)
Attachment Type	20	40
Combined Upper/Lower Grip Height	327 mm (12.9 in)	458 mm (18 in)
Grip Width	250 mm (9.8 in)	352 mm (13.9 in)

DX104A Optional Specimen Interfaces

Model	Part Number	Profile	Surface	Height	Width	Temperature Range	Specimen Range
DX104A-07	100-302-880	Flat	Sawtooth Steel	54 mm (2.1 in)	40 mm (1.6 in)	0° C (32° F) to 50° C (122° F)	0-20 mm (0-0.8 in)
DX104A-07a	100-311-711	Flat	Smooth Steel w/SiC coating	54 mm (2.1 in)	40 mm (1.6 in)	0° C (32° F) to 50° C (122° F)	0-20 mm (0-0.8 in)
DX104A-23	100-302-881	Vee	Serrated Steel	54 mm (2.1 in)	40 mm (1.6 in)	0° C (32° F) to 50° C (122° F)	ø4-ø9 mm (0.2-0.4 in)
DX104A-24	100-302-882	Vee	Serrated Steel	54 mm (2.1 in)	40 mm (1.6 in)	0° C (32° F) to 50° C (122° F)	ø9-ø14 mm (0.4-0.6 in)

DX105A Optional Specimen Interfaces

DX105A-18	100-302-884	Flat	Sawtooth Steel	70 mm (2.8 in)	60 mm (2.4 in)	0° C (32° F) to 50° C (122° F)	0-20 mm (0-0.55 in)
DX105A-19	100-302-885	Vee	Serrated Steel	70 mm (2.8 in)	60 mm (2.4 in)	0° C (32° F) to 50° C (122° F)	ø14-19 mm (ø0.55-0.75 in)

Tension Grips

Manual Activation

MTS Advantage Wedge Grips

- » High-performance, versatile wedge grips with higher clamping force than screw or pneumatic grips
- » Faces remain stationary during loading to minimize compressive or buckling forces during specimen insertion
- » Anti-rotation features and integrated alignment pins enhance test accuracy and repeatability
- » Available with interchangeable faces for serrated wedges for round or flat specimens
- » Self-tightening during testing reduces slippage
- » Grips are sold in pairs
- » All specimen interfaces (“wedges”) are sold separately
- » **Applications:** Tensile testing of metals, composites, ceramics, plastics and wood/paper products
- » *See page 34 for wedge options*



Specifications

Model	AWG104	AWG304	AWG504	AWG105	AWG305
Part Number	056-079-501	052-862-001	054-951-001	056-079-801	100-270-777
Grip Type	Manual Wedge	Manual Wedge	Manual Wedge	Manual Wedge	Manual Wedge
Force Capacity	10 kN (2,250 lbf)	30 kN (6,740 lbf)	50 kN (11,240 lbf)	100 kN (22,480 lbf)	300 kN (67,440 lbf)
Upper Grip Weight	4.6 kg (10.0 lb)	5 kg (11 lb)	6.4 kg (14 lb)	13.6 kg (30 lb)	53.5 kg (118 lb)
Temperature Rating	-130° C (-200° F) to 315° C (600° F)	-130° C (-200° F) to 315° C (600° F)	-130° C (-200° F) to 315° C (600° F)	-130° C (-200° F) to 315° C (600° F)	-130° C (-200° F) to 315° C (600° F)
Attachment Type	D	D	D	D	E
Combined Upper/Lower Grip Height	432 mm (17 in)	494 mm (19.5 in)	504 mm (19.8 in)	528 mm (20.8 in)	686 mm (27 in)
Grip Width	197 mm (7.8 in)	197 mm (7.8 in)	206 mm (8.1 in)	243 mm (in)	407 mm (16.0 in)

Tension Grips

Manual Activation

MTS Fundamental Wedge Grips

- » Affordable wedge grips for higher force testing needs
- » Design minimizes compressive or buckling forces during specimen insertion
- » Anti-rotation features and integrated alignment pins enhance test accuracy and repeatability
- » Grips are sold in pairs
- » All specimen interfaces ("wedges") are sold separately
- » **Applications:** Tensile testing of strong plastics, aluminum and steel
- » See page 35 for wedge options



Specifications

Model	FXSA104B	FXSA304B	FXSA105A	FXSA305A
Part Number	100-257-698	100-231-404	100-231-405	100-257-525
Grip Type	Manual Wedge	Manual Wedge	Manual Wedge	Manual Wedge
Force Capacity	10 kN (2,250 lbf)	30 kN (6,740 lbf)	100 kN (22,480 lbf)	300 kN (67,440 lbf)
Upper Grip Weight	3.10 kg (6.8 lb)	9.19 kg (20.3 lb)	14.79 kg (32.6 lb)	26.0 kg (57.3 lb)
Temperature Rating	0° C (32° F) to 50° C (122° F)	0° C (32° F) to 50° C (122° F)	0° C (32° F) to 50° C (122° F)	0° C (32° F) to 50° C (122° F)
Attachment Type	D	D	D	E
Combined Upper/Lower Grip Height	344 mm (13.5 in)	538 mm (21.2 in)	626 mm (24.6 in)	688 mm (27.1 in)
Grip Width	104 mm (4.09 in)	370 mm (14.567 in)	370 mm (14.567 in)	385 mm (15.2 in)

Tension Wedges

Model 647.02B Grip & MTS Advantage APG104 Grip Optional Wedges

Model	Part Number	Profile	Surface	Height	Width	Temperature Range	Specimen Range	Compatible Grip(s)
647.02B.01	050-507-901	Flat	Sawtooth Steel	38 mm (1.5 in)	25 mm (1.0 in)	-40° C (-40° F) to 177° C (350° F)	13.4-20.5 mm (0.53-0.81 in)	647.02B
647.02B.02	050-507-904	Flat	Surfallooy	38 mm (1.5 in)	25 mm (1.0 in)	-40° C (-40° F) to 177° C (350° F)	13.4-20.5 mm (0.53-0.81 in)	647.02B
647.02B.03	050-507-905	Flat	Sawtooth Steel	38 mm (1.5 in)	25 mm (1.0 in)	-40° C (-40° F) to 177° C (350° F)	18.8-25.9 mm (0.74-1.02 in)	APG104, 647.02B
647.02B.04	050-507-906	Flat	Sawtooth Steel	38 mm (1.5 in)	25 mm (1.0 in)	-40° C (-40° F) to 177° C (350° F)	0-7.2 mm (0-0.28 in)	APG104, 647.02B
647.02B.05	050-507-907	Flat	Sawtooth Steel	38 mm (1.5 in)	25 mm (1.0 in)	-40° C (-40° F) to 177° C (350° F)	7.2-14.4 mm (0.28-0.57 in)	APG104, 647.02B
647.02B.06	050-507-908	Vee	Diamond Tip Steel	38 mm (1.5 in)	25 mm (1.0 in)	-40° C (-40° F) to 177° C (350° F)	ø3-8.1 mm (0.12-0.32 in) Side, ø9.4 mm (0.37 in) Top	APG104, 647.02B
647.02B.07	050-507-909	Vee	Diamond Tip Steel	38 mm (1.5 in)	25 mm (1.0 in)	-40° C (-40° F) to 177° C (350° F)	ø8.9-10.9 mm (0.35-0.43 in) Side, ø15.2 mm (0.60 in) Top	APG104, 647.02B
647.02B.08	050-507-910	Vee	Diamond Tip Steel	38 mm (1.5 in)	25 mm (1.0 in)	-40° C (-40° F) to 177° C (350° F)	ø14-18 mm (0.55-0.71 in) Side, ø20.8 mm (0.82 in) Top	APG104, 647.02B
647.02B.09	050-507-911	Vee	Diamond Tip Steel	38 mm (1.5 in)	25 mm (1.0 in)	-40° C (-40° F) to 177° C (350° F)	ø20.1-22.9 mm (0.79-0.90 in) Side, ø27.2 mm (1.07 in) Top	APG104, 647.02B
647.02B.10	050-507-912	Round	Surfallooy	38 mm (1.5 in)	25 mm (1.0 in)	-40° C (-40° F) to 177° C (350° F)	ø10.0 mm (0.3937 in)	647.02B
647.02B.11	050-507-913	Round	Surfallooy	38 mm (1.5 in)	25 mm (1.0 in)	-40° C (-40° F) to 177° C (350° F)	ø15.0 mm (0.5906 in)	APG104, 647.02B
647.02B.12	050-507-914	Round	Surfallooy	38 mm (1.5 in)	25 mm (1.0 in)	-40° C (-40° F) to 177° C (350° F)	Ø25.0 mm (0.9843 in)	647.02B
647.02B.13	050-507-915	Round	Surfallooy	38 mm (1.5 in)	25 mm (1.0 in)	-40° C (-40° F) to 177° C (350° F)	ø12.7 mm (0.5000 in)	APG104, 647.02B
647.02B.14	050-507-917	Flat	Surfallooy	38 mm (1.5 in)	25 mm (1.0 in)	-40° C (-40° F) to 177° C (350° F)	0-7.2 mm (0-0.28 in)	APG104, 647.02B
647.02B.15	050-507-918	Flat	Surfallooy	38 mm (1.5 in)	25 mm (1.0 in)	-40° C (-40° F) to 177° C (350° F)	7.2-14.4 mm (0.28-0.57 in)	647.02B
647.02B.16	054-585-001	Flat	Sawtooth Steel	38 mm (1.5 in)	50 mm (2.0 in)	-40° C (-40° F) to 177° C (350° F)	0-7.1 mm (0-0.28 in)	APG104, 647.02B
647.02B.17	054-585-002	Flat	Sawtooth Steel	38 mm (1.5 in)	50 mm (2.0 in)	-40° C (-40° F) to 177° C (350° F)	7.1-13.4 mm (0.28-0.57 in)	APG104, 647.02B
647.02B.18	054-585-003	Flat	Sawtooth Steel	38 mm (1.5 in)	50 mm (2.0 in)	-40° C (-40° F) to 177° C (350° F)	13.5-20.5 mm (0.53-0.81 in)	APG104, 647.02B
647.02B.19	054-585-004	Flat	Sawtooth Steel	38 mm (1.5 in)	50 mm (2.0 in)	-40° C (-40° F) to 177° C (350° F)	16.9-24.0 mm (0.66-0.95 in)	APG104, 647.02B
647.02B.20	052-818-701	Flat–water cooled	Diamond Tip Steel	38 mm (1.5 in)	25 mm (1.0 in)	-130° C (-200° F) to 315° C (600° F)	0-7.1 mm (0-0.28 in)	APG104, 647.02B
647.02B.21	052-818-702	Flat–water cooled	Surfallooy	38 mm (1.5 in)	25 mm (1.0 in)	-130° C (-200° F) to 315° C (600° F)	0-7.1 mm (0-0.28 in)	APG104, 647.02B

Tension Wedges

Model 647.10A Grip Optional Wedges

Model	Part Number	Profile	Surface	Height	Width	Temperature Range	Specimen Range	Compatible Grip(s)
647.10A.01	041-842-101	Flat	Diamond Tip Steel	63 mm (2.5 in)	44 mm x (1.75 in)	-40° C (-40° F) to 177° C (350° F)	0-7.6 mm (0-0.3 in)	647.10A
647.10A.02	041-842-102	Flat	Diamond Tip Steel	63 mm (2.5 in)	44 mm x (1.75 in)	-40° C (-40° F) to 177° C (350° F)	7.1-14.2 mm (0.28-0.56 in)	647.10A
647.10A.03	041-842-103	Vee	Serrated Steel	63 mm (2.5 in)	44 mm x (1.75 in)	-40° C (-40° F) to 177° C (350° F)	ø5.8-10.2 mm (0.23-0.4 in) Side, ø11.9 mm (0.47 in) Top	647.10A
647.10A.04	041-842-104	Vee	Serrated Steel	63 mm (2.5 in)	44 mm x (1.75 in)	-40° C (-40° F) to 177° C (350° F)	ø10.9-12.7 mm (0.43-0.5 in) Side, ø16.5 mm (0.65 in) Top	647.10A
647.10A.05	041-842-107	Vee	Serrated Steel	63 mm (2.5 in)	44 mm x (1.75 in)	-40° C (-40° F) to 177° C (350° F)	ø12.7-19.1 mm (0.5-0.75 in) Side & Top	647.10A
647.10A.06	041-842-108	Flat	Surfallo	63 mm (2.5 in)	44 mm x (1.75 in)	-40° C (-40° F) to 177° C (350° F)	0-7.9 mm (0-0.31 in)	647.10A
647.10A.07	041-842-109	Flat	Diamond Tip Steel	63 mm (2.5 in)	44 mm x (1.75 in)	-40° C (-40° F) to 177° C (350° F)	11.7-19.1 mm (0.46-0.75 in)	647.10A
647.10A.08	041-842-110	Vee	Serrated Steel	63 mm (2.5 in)	44 mm x (1.75 in)	-40° C (-40° F) to 177° C (350° F)	ø17-22.9 mm (0.67-0.9 in) Side & Top	647.10A
647.10A.09	041-842-111	Flat	Surfallo	63 mm (2.5 in)	44 mm x (1.75 in)	-40° C (-40° F) to 177° C (350° F)	7.1-14.2 mm (0.28-0.56 in)	647.10A
647.10A.10	041-842-121	Flat	Surfallo	63 mm (2.5 in)	44 mm x (1.75 in)	-40° C (-40° F) to 177° C (350° F)	11.7-19.1 mm (0.46-0.75 in)	647.10A
647.10A.11	041-842-132	Round	Surfallo	63 mm (2.5 in)	44 mm x (1.75 in)	-40° C (-40° F) to 177° C (350° F)	ø12.7 mm (0.5000 in)	647.10A
647.10A.12	041-842-133	Round	Surfallo	63 mm (2.5 in)	44 mm x (1.75 in)	-40° C (-40° F) to 177° C (350° F)	ø19.0 mm (0.7500 in)	647.10A
647.10A.13	041-842-134	Round	Surfallo	63 mm (2.5 in)	44 mm x (1.75 in)	-40° C (-40° F) to 177° C (350° F)	ø12.0 mm (0.4724 in)	647.10A
647.10A.14	041-842-135	Round	Surfallo	63 mm (2.5 in)	44 mm x (1.75 in)	-40° C (-40° F) to 177° C (350° F)	ø15.0 mm (0.5906 in)	647.10A
647.10A.15	041-842-136	Round	Surfallo	63 mm (2.5 in)	44 mm x (1.75 in)	-40° C (-40° F) to 177° C (350° F)	ø20.0 mm (0.7874 in)	647.10A
647.10A.16	041-842-149	Round	Surfallo	63 mm (2.5 in)	44 mm x (1.75 in)	-40° C (-40° F) to 177° C (350° F)	ø25.4 mm (1.0000 in)	647.10A
647.10A.17	046-198-601	Flat	Surfallo	63 mm (2.5 in)	76 mm x (3.0 in)	-40° C (-40° F) to 177° C (350° F)	7.1-14.2 mm (0.28-0.56 in)	647.10A
647.10A.18	046-198-602	Flat	Surfallo	63 mm (2.5 in)	76 mm x (3.0 in)	-40° C (-40° F) to 177° C (350° F)	0-7.6 mm (0-0.3 in)	647.10A
647.10A.19	046-198-603	Flat	Diamond Tip Steel	63 mm (2.5 in)	76 mm x (3.0 in)	-40° C (-40° F) to 177° C (350° F)	7.1-14.2 mm (0.28-0.56 in)	647.10A

(continued next page...)

Tension Wedges

Model 647.10A Grip Optional Wedges (continued)

Model	Part Number	Profile	Surface	Height	Width	Temperature Range	Specimen Range	Compatible Grip(s)
647.10A.20	046-198-604	Flat	Diamond Tip Steel	63 mm (2.5 in)	76 mm x (3.0 in)	-40° C (-40° F) to 177° C (350° F)	0-7.6 mm (0-0.3 in)	647.10A
647.10A.21	046-198-606	Flat	Diamond Tip Steel	63 mm (2.5 in)	76 mm x (3.0 in)	-40° C (-40° F) to 177° C (350° F)	17-25.4 mm (0.67-1.0 in)	647.10A
647.10A.22	046-198-610	Flat	Diamond Tip Steel	63 mm (2.5 in)	76 mm x (3.0 in)	-40° C (-40° F) to 177° C (350° F)	11.4-18.9 mm (0.45-0.75 in)	647.10A
647.10A.23	046-838-701	Flat–water cooled	Diamond Tip Steel	63 mm (2.5 in)	44 mm x (1.75 in)	-130° C (-200° F) to 315° C (600° F)	7.1-14.2 mm (0.28-0.56 in)	647.10A
647.10A.24	046-838-702	Flat–water cooled	Diamond Tip Steel	63 mm (2.5 in)	44 mm x (1.75 in)	-130° C (-200° F) to 315° C (600° F)	0-7.6 mm (0-0.3 in)	647.10A
647.10A.25	046-838-703	Vee–water cooled	Serrated Steel	63 mm (2.5 in)	44 mm x (1.75 in)	-130° C (-200° F) to 315° C (600° F)	ø5.8-10.2 mm (0.23-0.4 in) Side, ø11.9 mm (0.47 in) Top	647.10A
647.10A.26	046-838-704	Vee–water cooled	Serrated Steel	63 mm (2.5 in)	44 mm x (1.75 in)	-130° C (-200° F) to 315° C (600° F)	ø10.9-12.7 mm (0.43-0.5 in) Side, ø16.5 mm (0.65 in) Top	647.10A
647.10A.27	046-838-705	Flat–water cooled	Surf alloy	63 mm (2.5 in)	44 mm x (1.75 in)	-130° C (-200° F) to 315° C (600° F)	0-7.6 mm (0-0.3 in)	647.10A
647.10A.28	046-838-706	Flat–water cooled	Surf alloy	63 mm (2.5 in)	44 mm x (1.75 in)	-130° C (-200° F) to 315° C (600° F)	7.1-14.2 mm (0.28-0.56 in)	647.10A
647.10A.29	046-838-713	Flat–water cooled	Diamond Tip Steel	63 mm (2.5 in)	44 mm x (1.75 in)	-130° C (-200° F) to 315° C (600° F)	11.7-19.1 mm (0.46-0.75 in)	647.10A
647.10A.30	046-838-714	Round–water cooled	Surf alloy	63 mm (2.5 in)	44 mm x (1.75 in)	-130° C (-200° F) to 315° C (600° F)	ø12.7 mm (0.5000 in)	647.10A
647.10A.31	046-838-716	Round–water cooled	Surf alloy	63 mm (2.5 in)	44 mm x (1.75 in)	-130° C (-200° F) to 315° C (600° F)	ø12.0 mm (0.4724 in)	647.10A
647.10A.32	046-838-717	Round–water cooled	Surf alloy	63 mm (2.5 in)	44 mm x (1.75 in)	-130° C (-200° F) to 315° C (600° F)	ø15.0 mm (0.5906 in)	647.10A
647.10A.33	046-838-718	Round–water cooled	Surf alloy	63 mm (2.5 in)	44 mm x (1.75 in)	-130° C (-200° F) to 315° C (600° F)	ø20.0 mm (0.7874 in)	647.10A

Tension Wedges

Model 647.25A Grip Optional Wedges

Model	Part Number	Profile	Surface	Height	Width	Temperature Range	Specimen Range	Compatible Grip(s)
647.25A.01	041-842-201	Flat	Diamond Tip Steel	89 mm (3.5 in)	50 mm x (2.0 in)	-40° C (-40° F) to 177° C (350° F)	1-11.9 mm (0.04-0.47 in)	647.25A
647.25A.02	041-842-202	Flat	Diamond Tip Steel	89 mm (3.5 in)	50 mm x (2.0 in)	-40° C (-40° F) to 177° C (350° F)	6.1-17 mm (0.24-0.67 in)	647.25A
647.25A.03	041-842-203	Flat	Diamond Tip Steel	89 mm (3.5 in)	50 mm x (2.0 in)	-40° C (-40° F) to 177° C (350° F)	15-25.9 mm (0.59-1.02 in)	647.25A
647.25A.04	041-842-204	Vee	Serrated Steel	89 mm (3.5 in)	50 mm x (2.0 in)	-40° C (-40° F) to 177° C (350° F)	ø10.7-19.8 mm (0.42-0.78 in) Side & Top	647.25A
647.25A.05	041-842-205	Vee	Serrated Steel	89 mm (3.5 in)	50 mm x (2.0 in)	-40° C (-40° F) to 177° C (350° F)	ø16.8-26.2 mm (0.66-1.03 in) Side & Top	647.25A
647.25A.06	041-842-206	Vee	Serrated Steel	89 mm (3.5 in)	50 mm x (2.0 in)	-40° C (-40° F) to 177° C (350° F)	ø6.4-13.5 mm (0.25-0.53 in) Side & Top	647.25A
647.25A.07	041-842-207	Flat	Surfallo	89 mm (3.5 in)	50 mm x (2.0 in)	-40° C (-40° F) to 177° C (350° F)	1-11.9 mm (0.04-0.47 in)	647.25A
647.25A.08	041-842-208	Flat	Surfallo	89 mm (3.5 in)	50 mm x (2.0 in)	-40° C (-40° F) to 177° C (350° F)	6.1-17 mm (0.24-0.67 in)	647.25A
647.25A.09	041-842-209	Flat	Surfallo	89 mm (3.5 in)	50 mm x (2.0 in)	-40° C (-40° F) to 177° C (350° F)	15-25.9 mm (0.59-1.02 in)	647.25A
647.25A.10	041-842-231	Round	Surfallo	89 mm (3.5 in)	50 mm x (2.0 in)	-40° C (-40° F) to 177° C (350° F)	ø15.0 mm (0.5906 in)	647.25A
647.25A.11	041-842-232	Round	Surfallo	89 mm (3.5 in)	50 mm x (2.0 in)	-40° C (-40° F) to 177° C (350° F)	ø20.0 mm (0.7874 in)	647.25A
647.25A.12	041-842-233	Round	Surfallo	89 mm (3.5 in)	50 mm x (2.0 in)	-40° C (-40° F) to 177° C (350° F)	ø30.0 mm (1.1811 in)	647.25A
647.25A.13	041-842-234	Round	Surfallo	89 mm (3.5 in)	50 mm x (2.0 in)	-40° C (-40° F) to 177° C (350° F)	ø12.7 mm (0.5000 in)	647.25A
647.25A.14	041-842-235	Round	Surfallo	89 mm (3.5 in)	50 mm x (2.0 in)	-40° C (-40° F) to 177° C (350° F)	ø25.4 mm (1.0000 in)	647.25A
647.25A.15	046-198-801	Flat	Surfallo	89 mm (3.5 in)	102 mm x (4.0 in)	-40° C (-40° F) to 177° C (350° F)	0-10.1 mm (0-0.40 in)	647.25A
647.25A.16	046-198-802	Flat	Surfallo	89 mm (3.5 in)	102 mm x (4.0 in)	-40° C (-40° F) to 177° C (350° F)	6.1-17 mm (0.24-0.67 in)	647.25A
647.25A.17	046-198-803	Flat	Surfallo	89 mm (3.5 in)	102 mm x (4.0 in)	-40° C (-40° F) to 177° C (350° F)	15-25.9 mm (0.59-1.02 in)	647.25A
647.25A.18	046-198-804	Flat	Diamond Tip Steel	89 mm (3.5 in)	102 mm x (4.0 in)	-40° C (-40° F) to 177° C (350° F)	1-11.9 mm (0.04-0.47 in)	647.25A
647.25A.19	046-198-805	Flat	Diamond Tip Steel	89 mm (3.5 in)	102 mm x (4.0 in)	-40° C (-40° F) to 177° C (350° F)	15-25.9 mm (0.59-1.02 in)	647.25A

(continued next page...)

Tension Wedges

Model 647.25A Grip Optional Wedges (continued)

Model	Part Number	Profile	Surface	Height	Width	Temperature Range	Specimen Range	Compatible Grip(s)
647.25A.20	046-198-806	Flat	Diamond Tip Steel	89 mm (3.5 in)	102 mm x (4.0 in)	-40° C (-40° F) to 177° C (350° F)	6.1-17 mm (0.24-0.67 in)	647.25A
647.25A.21	046-198-817	Flat	Surfallo	89 mm (3.5 in)	102 mm x (4.0 in)	-40° C (-40° F) to 177° C (350° F)	1-11.9 mm (0.04-0.47 in)	647.25A
647.25A.22	045-966-201	Flat–water cooled	Diamond Tip Steel	89 mm (3.5 in)	50 mm x (2.0 in)	-130° C (-200° F) to 315° C (600° F)	1-11.9 mm (0.04-0.47 in)	647.25A
647.25A.23	045-966-202	Flat–water cooled	Diamond Tip Steel	89 mm (3.5 in)	50 mm x (2.0 in)	-130° C (-200° F) to 315° C (600° F)	6.1-17 mm (0.24-0.67 in)	647.25A
647.25A.24	045-966-203	Vee–water cooled	Serrated Steel	89 mm (3.5 in)	50 mm x (2.0 in)	-130° C (-200° F) to 315° C (600° F)	∅16.8-26.2 mm (0.66-1.03 in) Side & Top	647.25A
647.25A.25	045-966-204	Flat–water cooled	Diamond Tip Steel	89 mm (3.5 in)	50 mm x (2.0 in)	-130° C (-200° F) to 315° C (600° F)	15-25.9 mm (0.59-1.02 in)	647.25A
647.25A.26	045-966-205	Flat–water cooled	Surfallo	89 mm (3.5 in)	50 mm x (2.0 in)	-130° C (-200° F) to 315° C (600° F)	1-11.9 mm (0.04-0.47 in)	647.25A
647.25A.27	045-966-206	Vee–water cooled	Serrated Steel	89 mm (3.5 in)	50 mm x (2.0 in)	-130° C (-200° F) to 315° C (600° F)	∅6.4-13.5 mm (0.25-0.53 in) Side & Top	647.25A
647.25A.28	045-966-207	Vee–water cooled	Serrated Steel	89 mm (3.5 in)	50 mm x (2.0 in)	-130° C (-200° F) to 315° C (600° F)	∅10.7-19.8 mm (0.42-0.78 in) Side & Top	647.25A
647.25A.29	045-966-208	Flat–water cooled	Sawtooth Steel	89 mm (3.5 in)	50 mm x (2.0 in)	-130° C (-200° F) to 315° C (600° F)	1-11.9 mm (0.04-0.47 in)	647.25A
647.25A.30	045-966-209	Flat–water cooled	Sawtooth Steel	89 mm (3.5 in)	50 mm x (2.0 in)	-130° C (-200° F) to 315° C (600° F)	6.1-17 mm (0.24-0.67 in)	647.25A
647.25A.31	045-966-210	Flat–water cooled	Sawtooth Steel	89 mm (3.5 in)	50 mm x (2.0 in)	-130° C (-200° F) to 315° C (600° F)	15-25.9 mm (0.59-1.02 in)	647.25A

Tension Wedges

Model 647.50A Grip Optional Wedges

Model	Part Number	Profile	Surface	Height	Width	Temperature Range	Specimen Range	Compatible Grip(s)
647.50A.01	047-641-601	Vee	Serrated Steel	95 mm (3.75 in)	102 mm x (4.0 in)	-40° C (-40° F) to 177° C (350° F)	ø6.4-15.5 mm (0.25-0.61 in) Side & Top	647.50A
647.50A.02	047-641-602	Vee	Serrated Steel	95 mm (3.75 in)	102 mm x (4.0 in)	-40° C (-40° F) to 177° C (350° F)	ø15.2-24.4 mm (0.60-0.96 in) Side & Top	647.50A
647.50A.03	047-641-603	Vee	Serrated Steel	95 mm (3.75 in)	102 mm x (4.0 in)	-40° C (-40° F) to 177° C (350° F)	ø24.1-33.5 mm (0.95-1.32 in) Side & Top	647.50A
647.50A.04	047-641-604	Vee	Serrated Steel	95 mm (3.75 in)	102 mm x (4.0 in)	-40° C (-40° F) to 177° C (350° F)	ø33-42.4 mm (1.30-1.67 in) Side & Top	647.50A
647.50A.05	047-641-605	Vee	Serrated Steel	95 mm (3.75 in)	102 mm x (4.0 in)	-40° C (-40° F) to 177° C (350° F)	ø41.9-51.3 mm (1.65-2.02 in) Side & Top	647.50A
647.50A.06	047-641-606	Flat	Diamond Tip Steel	95 mm (3.75 in)	102 mm x (4.0 in)	-40° C (-40° F) to 177° C (350° F)	0-10.9 mm (0-0.43 in)	647.50A
647.50A.07	047-641-607	Flat	Diamond Tip Steel	95 mm (3.75 in)	102 mm x (4.0 in)	-40° C (-40° F) to 177° C (350° F)	10.2-21.1 mm (0.40-0.83 in)	647.50A
647.50A.08	047-641-608	Flat	Diamond Tip Steel	95 mm (3.75 in)	1102 mm x (4.0 in)	-40° C (-40° F) to 177° C (350° F)	20.3-31.2 mm (0.80-1.23 in)	647.50A
647.50A.09	047-641-609	Flat	Diamond Tip Steel	95 mm (3.75 in)	102 mm x (4.0 in)	-40° C (-40° F) to 177° C (350° F)	30.5-41.4 mm (1.20-1.63 in)	647.50A
647.50A.10	047-641-610	Flat	Diamond Tip Steel	95 mm (3.75 in)	102 mm x (4.0 in)	-40° C (-40° F) to 177° C (350° F)	40.6-51.6 mm (1.60-2.03 in)	647.50A
647.50A.11	047-641-611	Flat	Surfallo	95 mm (3.75 in)	102 mm x (4.0 in)	-40° C (-40° F) to 177° C (350° F)	0-10.9 mm (0-0.43 in)	647.50A
647.50A.12	047-641-612	Flat	Surfallo	95 mm (3.75 in)	102 mm x (4.0 in)	-40° C (-40° F) to 177° C (350° F)	10.2-21.1 mm (0.40-0.83 in)	647.50A
647.50A.13	047-641-613	Flat	Surfallo	95 mm (3.75 in)	102 mm x (4.0 in)	-40° C (-40° F) to 177° C (350° F)	20.3-31.2 mm (0.80-1.23 in)	647.50A
647.50A.14	048-966-301	Flat	Surfallo	95 mm (3.75 in)	102 mm x (4.0 in)	-40° C (-40° F) to 177° C (350° F)	20.3-31.2 mm (0.80-1.23 in)	647.50A
647.50A.15	048-966-303	Flat	Diamond Tip Steel	95 mm (3.75 in)	102 mm x (4.0 in)	-40° C (-40° F) to 177° C (350° F)	10.2-21.1 mm (0.40-0.83 in)	647.50A
647.50A.16	048-966-304	Flat	Diamond Tip Steel	95 mm (3.75 in)	102 mm x (4.0 in)	-40° C (-40° F) to 177° C (350° F)	20.3-31.2 mm (0.80-1.23 in)	647.50A
647.50A.17	048-966-305	Flat	Diamond Tip Steel	95 mm (3.75 in)	102 mm x (4.0 in)	-40° C (-40° F) to 177° C (350° F)	30.5-41.4 mm (1.20-1.63 in)	647.50A
647.50A.18	048-966-306	Flat	Diamond Tip Steel	95 mm (3.75 in)	102 mm x (4.0 in)	-40° C (-40° F) to 177° C (350° F)	40.6-51.6 mm (1.60-2.03 in)	647.50A
647.50A.19	048-966-307	Flat	Surfallo	95 mm (3.75 in)	102 mm x (4.0 in)	-40° C (-40° F) to 177° C (350° F)	0-10.9 mm (0-0.43 in)	647.50A

Tension Wedges

AWG104, AWG304 & AWG504 Grip Optional Wedges

Model	Part Number	Profile	Surface	Height	Width	Temperature Range	Specimen Range	Compatible Grip(s)
AWG504.01	053-140-801	Flat	Sawtooth Steel	50 mm (2.0 in)	25 mm (1.0 in)	-130° C (-200° F) to 315° C (600° F)	0-7.9 mm (0-0.31 in)	AWG104 AWG304 AWG504
AWG504.02	053-140-802	Flat	Sawtooth Steel	50 mm (2.0 in)	25 mm (1.0 in)	-130° C (-200° F) to 315° C (600° F)	6-13.2 mm (0.23-0.52 in)	AWG104 AWG304 AWG504
AWG504.03	053-140-803	Vee	Serrated Steel	50 mm (2.0 in)	25 mm (1.0 in)	-130° C (-200° F) to 315° C (600° F)	ø3-7.9 mm (0.12-0.31 in) Side, ø7.9 mm (0.31 in) Top	AWG104 AWG304 AWG504
AWG504.04	053-140-804	Vee	Serrated Steel	50 mm (2.0 in)	25 mm (1.0 in)	-130° C (-200° F) to 315° C (600° F)	ø7-9.5 mm (0.27-0.38 in) Side, ø12.7 mm (0.50 in) Top	AWG104 AWG304 AWG504
AWG504.05	053-140-805	Vee	Serrated Steel	50 mm (2.0 in)	25 mm (1.0 in)	-130° C (-200° F) to 315° C (600° F)	ø11.5-12.7 mm (0.45-0.50 in) Side, ø16 mm (0.63 in) Top	AWG104 AWG304 AWG504
AWG504.06	053-140-806	Flat	Surfallooy	50 mm (2.0 in)	25 mm (1.0 in)	-130° C (-200° F) to 315° C (600° F)	0-7.9 mm (0-0.31 in)	AWG104 AWG304 AWG504
AWG504.07	053-140-807	Vee	Serrated Steel	50 mm (2.0 in)	25 mm (1.0 in)	-130° C (-200° F) to 315° C (600° F)	ø1.5-5 mm (0.06-0.20 in) Side, ø5 mm (0.20 in) Top	AWG104 AWG304 AWG504

AWG105 & AWG305 Grip Optional Wedges

Model	Part Number	Profile	Surface	Height	Width	Temperature Range	Specimen Range	Compatible Grip(s)
AWG305.01	053-537-401	Flat	Sawtooth Steel	70 mm (2.75 in)	50 mm (2.0 in)	-130° C (-200° F) to 315° C (600° F)	0-9 mm (0-0.35 in)	AWG105 AWG305
AWG305.02	053-537-402	Flat	Sawtooth Steel	70 mm (2.75 in)	50 mm (2.0 in)	-130° C (-200° F) to 315° C (600° F)	6.4-16 mm (0.25-0.63 in)	AWG105 AWG305
AWG305.03	053-537-403	Vee	Serrated Steel	70 mm (2.75 in)	50 mm (2.0 in)	-130° C (-200° F) to 315° C (600° F)	ø5-10.4 mm (0.20-0.41 in) Side, ø12.5 mm (0.49 in) Top	AWG105 AWG305
AWG305.04	053-537-404	Vee	Serrated Steel	70 mm (2.75 in)	50 mm (2.0 in)	-130° C (-200° F) to 315° C (600° F)	ø12.2-16.5 mm (0.48-0.61 in) Side, ø19.5 mm (0.77 in) Top	AWG105 AWG305
AWG305.05	053-537-405	Vee	Serrated Steel	70 mm (2.75 in)	50 mm (2.0 in)	-130° C (-200° F) to 315° C (600° F)	ø3.2-5.8 mm (0.12-0.23 in) Side, ø7.6 mm (0.30 in) Top	AWG105 AWG305
AWG305.06	053-537-406	Flat	Surfallooy	70 mm (2.75 in)	50 mm (2.0 in)	-130° C (-200° F) to 315° C (600° F)	0-9 mm (0-0.35 in)	AWG105 AWG305
AWG305.07	053-537-407	Round	Surfallooy	770 mm (2.75 in)	50 mm (2.0 in)	-130° C (-200° F) to 315° C (600° F)	ø12.70 mm (0.5000 in)	AWG105 AWG305

Tension Wedges

FXSA104B Grip Optional Wedges

Model	Part Number	Profile	Surface	Height	Width	Temperature Range	Specimen Range	Compatible Grip Model
FXSA104B.01 x 2	100-258-168	Flat	Sawtooth Steel	40 mm (1.6 in)	35 mm (1.4 in)	0° C (32° F) to 50° C (122° F)	0-7 mm (0-0.28 in)	FXSA104B
FXSA104B.02 x 2	100-258-169	Flat	Sawtooth Steel	40 mm (1.6 in)	35 mm (1.4 in)	0° C (32° F) to 50° C (122° F)	7-13 mm (0.28-0.51 in)	FXSA104B
FXSA104B.03 x 2	100-258-170	Vee	Serrated Steel	40 mm (1.6 in)	35 mm (1.4 in)	0° C (32° F) to 50° C (122° F)	ø4-ø9 mm (ø0.16-ø0.35 in)	FXSA104B
FXSA104B.04 x 2	100-258-171	Vee	Serrated Steel	40 mm (1.6 in)	35 mm (1.4 in)	0° C (32° F) to 50° C (122° F)	ø9-ø14 mm (ø0.35-ø0.55 in)	FXSA104B

FXSA304A & FXSA105A Grip Optional Wedges

FXSA105A.01	100-231-648	Flat	Sawtooth Steel	55 mm (2.2 in)	40 mm (1.6 in)	0° C (32° F) to 50° C (122° F)	0-7 mm (0-0.28 in)	FXSA304A FXSA105A
FXSA105A.02	100-231-649	Flat	Sawtooth Steel	55 mm (2.2 in)	40 mm (1.6 in)	0° C (32° F) to 50° C (122° F)	7-14 mm (0.28-0.55 in)	FXSA304A FXSA105A
FXSA105A.03	100-231-650	Flat	Sawtooth Steel	55 mm (2.2 in)	40 mm (1.6 in)	0° C (32° F) to 50° C (122° F)	14-21 mm (0.55-0.83 in)	FXSA304A FXSA105A
FXSA105A.04	100-231-651	Vee	Serrated Steel	55 mm (2.2 in)	40 mm (1.6 in)	0° C (32° F) to 50° C (122° F)	ø4-ø9 mm (ø0.16-ø0.35 in)	FXSA304A FXSA105A
FXSA105A.05	100-231-652	Vee	Serrated Steel	55 mm (2.2 in)	40 mm (1.6 in)	0° C (32° F) to 50° C (122° F)	ø9-ø14 mm (ø0.35-ø0.55 in)	FXSA304A FXSA105A
FXSA105A.06	100-231-653	Vee	Serrated Steel	55 mm (2.2 in)	440 mm (1.6 in)	0° C (32° F) to 50° C (122° F)	ø14-ø19 mm (ø0.55-ø0.75 in)	FXSA304A FXSA105A

FXSA305A Grip Optional Wedges

FXSA305A.01 x 2	100-258-160	Flat	Sawtooth Steel	62 mm (2.4 in)	50 mm (2.0 in)	0° C (32° F) to 50° C (122° F)	0-8 mm (0-0.32 in)	FXSA305A
FXSA305A.02 x 2	100-258-161	Flat	Sawtooth Steel	62 mm (2.4 in)	50 mm (2.0 in)	0° C (32° F) to 50° C (122° F)	8-16 mm (0.32-0.63 in)	FXSA305A
FXSA305A.03 x 2	100-258-162	Flat	Sawtooth Steel	62 mm (2.4 in)	50 mm (2.0 in)	0° C (32° F) to 50° C (122° F)	16-24 mm (0.63-0.95 in)	FXSA305A
FXSA305A.04 x 2	100-258-163	Flat	Sawtooth Steel	62 mm (2.4 in)	50 mm (2.0 in)	0° C (32° F) to 50° C (122° F)	24-32 mm (0.95-1.26 in)	FXSA305A
FXSA305A.05 x 2	100-258-164	Vee	Serrated Steel	62 mm (2.4 in)	50 mm (2.0 in)	0° C (32° F) to 50° C (122° F)	ø4-ø9 mm (ø0.16-ø0.35 in)	FXSA305A
FXSA305A.06 x 2	100-258-165	Vee	Serrated Steel	62 mm (2.4 in)	50 mm (2.0 in)	0° C (32° F) to 50° C (122° F)	ø9-ø16 mm (ø0.35-ø0.63 in)	FXSA305A
FXSA305A.07 x 2	100-258-166	Vee	Serrated Steel	62 mm (2.4 in)	50 mm (2.0 in)	0° C (32° F) to 50° C (122° F)	ø16-ø23 mm (ø0.63-ø0.91 in)	FXSA305A
FXSA305A.08 x 2	100-258-167	Vee	Serrated Steel	62 mm (2.4 in)	50 mm (2.0 in)	0° C (32° F) to 50° C (122° F)	ø23-ø30 mm (ø0.91-ø1.18 in)	FXSA305A

Tension Faces

FYD305 Grip Optional Faces

Model	Part Number	Profile	Surface	Height	Width	Temperature Range	Specimen Range	Compatible Grip(s)
FYD305.01	100-465-487	Flat	Sawtooth Steel	68 mm (2.7 in)	70 mm (2.75 in)	0° C (32° F) to 50° C (122° F)	0-6 mm (0-0.23 in)	FYD305
FYD305.02	100-465-488	Flat	Sawtooth Steel	68 mm (2.7 in)	70 mm (2.75 in)	0° C (32° F) to 50° C (122° F)	6-18 mm (0.23-0.7 in)	FYD305
FYD305.03	100-465-489	Flat	Sawtooth Steel	68 mm (2.7 in)	70 mm (2.75 in)	0° C (32° F) to 50° C (122° F)	18-30 mm (0.7-1.18 in)	FYD305
FYD305.04	100-465-484	Vee	Serrated Steel	68 mm (2.7 in)	70 mm (2.75 in)	0° C (32° F) to 50° C (122° F)	Ø6-16 mm (0.23-0.63 in) Side & Top	FYD305
FYD305.05	100-465-485	Vee	Serrated Steel	68 mm (2.7 in)	70 mm (2.75 in)	0° C (32° F) to 50° C (122° F)	Ø16-26 mm (0.63-1.02 in) Side & Top	FYD305
FYD305.06	100-465-486	Vee	Serrated Steel	68 mm (2.7 in)	70 mm (2.75 in)	0° C (32° F) to 50° C (122° F)	Ø26-36 mm (1.02-1.41 in) Side & Top	FYD305
FYD305.07	100-465-490	Vee	Rebar	68 mm (2.7 in)	70 mm (2.75 in)	0° C (32° F) to 50° C (122° F)	Ø6-16 mm (0.23-0.63 in)	FYD305
FYD305.08	100-465-491	Vee	Rebar	68 mm (2.7 in)	70 mm (2.75 in)	0° C (32° F) to 50° C (122° F)	Ø16-26 mm (0.63-1.02 in)	FYD305
FYD305.09	100-465-492	Vee	Rebar	68 mm (2.7 in)	70 mm (2.75 in)	0° C (32° F) to 50° C (122° F)	Ø26-36 mm (1.02-1.42 in)	FYD305
FYD305.10	100-629-970	Flat	Sawtooth Steel	68 mm (2.7 in)	70 mm (2.75 in)	0° C (32° F) to 50° C (122° F)	30-36 mm (1.18-1.42 in)	FYD305
FYD305.11	100-629-971	Flat	Sawtooth Steel	68 mm (2.7 in)	70 mm (2.75 in)	0° C (32° F) to 50° C (122° F)	36-40 mm (1.42-1.57 in)	FYD305

FYD605 Grip Optional Faces

FYD605.01	100-490-363	Flat	Sawtooth Steel	83 mm (3.3 in)	90 mm (3.5 in)	0° C (32° F) to 50° C (122° F)	0-6 mm (0-0.23 in)	FYD605
FYD605.02	100-490-364	Flat	Sawtooth Steel	83 mm (3.3 in)	90 mm (3.5 in)	0° C (32° F) to 50° C (122° F)	6-23 mm (0.23-0.9 in)	FYD605
FYD605.03	100-490-365	Flat	Sawtooth Steel	83 mm (3.3 in)	90 mm (3.5 in)	0° C (32° F) to 50° C (122° F)	23-40 mm (0.9-1.57 in)	FYD605
FYD605.04	100-490-366	Vee	Sawtooth Steel	83 mm (3.3 in)	90 mm (3.5 in)	0° C (32° F) to 50° C (122° F)	Ø6-12 mm (0.23-0.47 in)	FYD605
FYD605.05	100-490-367	Vee	Sawtooth Steel	83 mm (3.3 in)	90 mm (3.5 in)	0° C (32° F) to 50° C (122° F)	Ø12-27 mm (0.47-1.06 in)	FYD605
FYD605.06	100-490-368	Vee	Sawtooth Steel	83 mm (3.3 in)	90 mm (3.5 in)	0° C (32° F) to 50° C (122° F)	Ø27-42 mm (1.06-1.65 in)	FYD605
FYD605.07	100-490-369	Vee	Rebar	83 mm (3.3 in)	90 mm (3.5 in)	0° C (32° F) to 50° C (122° F)	Ø6-12 mm (0.23-0.47 in)	FYD605
FYD605.08	100-490-370	Vee	Rebar	83 mm (3.3 in)	90 mm (3.5 in)	0° C (32° F) to 50° C (122° F)	Ø12-27 mm (0.47-1.06 in)	FYD605
FYD605.09	100-490-371	Vee	Rebar	83 mm (3.3 in)	90 mm (3.5 in)	0° C (32° F) to 50° C (122° F)	Ø27-42 mm (1.06-1.65 in)	FYD605
FYD605.10	100-504-191	Vee	Sawtooth Steel	83 mm (3.3 in)	90 mm (3.5 in)	0° C (32° F) to 50° C (122° F)	Ø4-6 mm (0.15-0.23 in)	FYD605

Tension Faces

APG101 Grip Optional Faces

Model	Part Number	Profile	Surface	Height	Width	Temperature Range	Specimen Range	Compatible Grip Model
APG101.01	056-163-701	Flat	Smooth Steel	8 mm (0.3 in)	15 mm (0.6 in)	-40° C (-40° F) to 200° C (400° F)	0-5 mm (0-0.2 in)	APG101
APG101.02	056-163-702	Flat	Serrated Steel	8 mm (0.3 in)	15 mm (0.6 in)	-40° C (-40° F) to 200° C (400° F)	0-5 mm (0-0.2 in)	APG101
APG101.03	056-163-703	Flat	Smooth Rubber	8 mm (0.3 in)	15 mm (0.6 in)	-40° C (-40° F) to 200° C (400° F)	0-5 mm (0-0.2 in)	APG101

APG202 & APG203 and ASG102 & ASG203 Grip Optional Faces

Model	Part Number	Profile	Surface	Height	Width	Temperature Range	Specimen Range	Compatible Grip Model
APG203.01	056-163-801	Flat	Smooth Steel	25 mm (1.0 in)	25 mm (1.0 in)	-40° C (-40° F) to 200° C (400° F)	APG202: 0-10 mm (0-0.39 in) APG203: 0-12 mm (0-0.47 in) ASG102: 0-12 mm (0-0.47 in) ASG203: 0-19 mm (0-0.75 in)	APG202 APG203 ASG102 ASG203
APG203.02	056-163-802	Flat	Corrugated Rubber	25 mm (1.0 in)	25 mm (1.0 in)	-40° C (-40° F) to 200° C (400° F)	APG202: 0-10 mm (0-0.39 in) APG203: 0-12 mm (0-0.47 in) ASG102: 0-12 mm (0-0.47 in) ASG203: 0-19 mm (0-0.75 in)	APG202 APG203 ASG102 ASG203
APG203.03	056-163-803	Flat	Serrated Steel	25 mm (1.0 in)	25 mm (1.0 in)	-40° C (-40° F) to 200° C (400° F)	APG202: 0-10 mm (0-0.39 in) APG203: 0-12 mm (0-0.47 in) ASG102: 0-12 mm (0-0.47 in) ASG203: 0-19 mm (0-0.75 in)	APG202 APG203 ASG102 ASG203
APG203.04	056-163-804	Flat	Diamond Tip Steel	25 mm (1.0 in)	25 mm (1.0 in)	-40° C (-40° F) to 200° C (400° F)	APG202: 0-10 mm (0-0.39 in) APG203: 0-12 mm (0-0.47 in) ASG102: 0-12 mm (0-0.47 in) ASG203: 0-19 mm (0-0.75 in)	APG202 APG203 ASG102 ASG203
APG203.05	056-163-805	Flat	Matte Rubber	25 mm (1.0 in)	25 mm (1.0 in)	0° C (32° F) to 50° C (122° F)	APG202: 0-10 mm (0-0.39 in) APG203: 0-12 mm (0-0.47 in) ASG102: 0-12 mm (0-0.47 in) ASG203: 0-19 mm (0-0.75 in)	APG202 APG203 ASG102 ASG203
APG203.06	056-163-806	Flat	Corrugated Rubber	25 mm (1.0 in)	25 mm (1.0 in)	0° C (32° F) to 50° C (122° F)	APG202: 0-10 mm (0-0.39 in) APG203: 0-12 mm (0-0.47 in) ASG102: 0-12 mm (0-0.47 in) ASG203: 0-19 mm (0-0.75 in)	APG202 APG203 ASG102 ASG203
APG203.07	056-163-807	Flat	Smooth Rubber	25 mm (1.0 in)	25 mm (1.0 in)	0° C (32° F) to 50° C (122° F)	APG202: 0-10 mm (0-0.39 in) APG203: 0-12 mm (0-0.47 in) ASG102: 0-12 mm (0-0.47 in) ASG203: 0-19 mm (0-0.75 in)	APG202 APG203 ASG102 ASG203
APG203.08	056-163-808	Flat	Line Contact steel R4.75 mm (0.187 in)	13 mm (0.5 in)	25 mm (1.0 in)	-40° C (-40° F) to 200° C (400° F)	APG202: 0-10 mm (0-0.39 in) APG203: 0-12 mm (0-0.47 in) ASG102: 0-12 mm (0-0.47 in) ASG203: 0-19 mm (0-0.75 in)	APG202 APG203 ASG102 ASG203
APG203.09	056-163-809	Flat	Smooth Steel	25 mm (1.0 in)	75 mm (3.0 in)	-40° C (-40° F) to 200° C (400° F)	APG202: 0-10 mm (0-0.39 in) APG203: 0-12 mm (0-0.47 in) ASG102: 0-12 mm (0-0.47 in) ASG203: 0-19 mm (0-0.75 in)	APG202 APG203 ASG102 ASG203
APG203.10	056-163-810	Flat	Corrugated Steel	25 mm (1.0 in)	75 mm (3.0 in)	-40° C (-40° F) to 200° C (400° F)	APG202: 0-10 mm (0-0.39 in) APG203: 0-12 mm (0-0.47 in) ASG102: 0-12 mm (0-0.47 in) ASG203: 0-19 mm (0-0.75 in)	APG202 APG203 ASG102 ASG203

(continued next page...)

Tension Faces

APG202 & APG203 and ASG102 & ASG203 Grip Optional Faces (continued)

Model	Part Number	Profile	Surface	Height	Width	Temperature Range	Specimen Range	Compatible Grip Model
APG203.11	056-163-811	Flat	Serrated Steel	25 mm (1.0 in)	75 mm (3.0 in)	-40° C (-40° F) to 200° C (400° F)	APG202: 0-10 mm (0-0.39 in) APG203: 0-12 mm (0-0.47 in) ASG102: 0-12 mm (0-0.47 in) ASG203: 0-19 mm (0-0.75 in)	APG202 APG203 ASG102 ASG203
APG203.12	056-163-812	Flat	Diamond Tip Steel	25 mm (1.0 in)	75 mm (3.0 in)	-40° C (-40° F) to 200° C (400° F)	APG202: 0-10 mm (0-0.39 in) APG203: 0-12 mm (0-0.47 in) ASG102: 0-12 mm (0-0.47 in) ASG203: 0-19 mm (0-0.75 in)	APG202 APG203 ASG102 ASG203
APG203.13	056-163-813	Flat	Matte Rubber	25 mm (1.0 in)	75 mm (3.0 in)	0° C (32° F) to 50° C (122° F)	APG202: 0-10 mm (0-0.39 in) APG203: 0-12 mm (0-0.47 in) ASG102: 0-12 mm (0-0.47 in) ASG203: 0-19 mm (0-0.75 in)	APG202 APG203 ASG102 ASG203
APG203.14	056-163-814	Flat	Corrugated Rubber	25 mm (1.0 in)	75 mm (3.0 in)	0° C (32° F) to 50° C (122° F)	APG202: 0-10 mm (0-0.39 in) APG203: 0-12 mm (0-0.47 in) ASG102: 0-12 mm (0-0.47 in) ASG203: 0-19 mm (0-0.75 in)	APG202 APG203 ASG102 ASG203
APG203.15	056-163-815	Flat	Smooth Rubber	25 mm (1.0 in)	75 mm (3.0 in)	0° C (32° F) to 50° C (122° F)	APG202: 0-10 mm (0-0.39 in) APG203: 0-12 mm (0-0.47 in) ASG102: 0-12 mm (0-0.47 in) ASG203: 0-19 mm (0-0.75 in)	APG202 APG203 ASG102 ASG203
APG203.16	056-163-816	Flat	Smooth Steel	38 mm (1.5 in)	58 mm (2.3 in)	-40° C (-40° F) to 200° C (400° F)	APG202: 0-10 mm (0-0.39 in) APG203: 0-12 mm (0-0.47 in) ASG102: 0-12 mm (0-0.47 in) ASG203: 0-19 mm (0-0.75 in)	APG202 APG203 ASG102 ASG203
APG203.17	056-163-817	Flat	Corrugated Steel	38 mm (1.5 in)	58 mm (2.3 in)	-40° C (-40° F) to 200° C (400° F)	APG202: 0-10 mm (0-0.39 in) APG203: 0-12 mm (0-0.47 in) ASG102: 0-12 mm (0-0.47 in) ASG203: 0-19 mm (0-0.75 in)	APG202 APG203 ASG102 ASG203
APG203.18	056-163-818	Flat	Serrated Steel	38 mm (1.5 in)	58 mm (2.3 in)	-40° C (-40° F) to 200° C (400° F)	APG202: 0-10 mm (0-0.39 in) APG203: 0-12 mm (0-0.47 in) ASG102: 0-12 mm (0-0.47 in) ASG203: 0-19 mm (0-0.75 in)	APG202 APG203 ASG102 ASG203
APG203.19	056-163-819	Flat	Diamond Tip Steel	38 mm (1.5 in)	58 mm (2.3 in)	-40° C (-40° F) to 200° C (400° F)	APG202: 0-10 mm (0-0.39 in) APG203: 0-12 mm (0-0.47 in) ASG102: 0-12 mm (0-0.47 in) ASG203: 0-19 mm (0-0.75 in)	APG202 APG203 ASG102 ASG203
APG203.20	056-163-820	Flat	Matte Rubber	38 mm (1.5 in)	58 mm (2.3 in)	0° C (32° F) to 50° C (122° F)	APG202: 0-10 mm (0-0.39 in) APG203: 0-12 mm (0-0.47 in) ASG102: 0-12 mm (0-0.47 in) ASG203: 0-19 mm (0-0.75 in)	APG202 APG203 ASG102 ASG203
APG203.21	056-163-821	Flat	Corrugated Rubber	38 mm (1.5 in)	58 mm (2.3 in)	0° C (32° F) to 50° C (122° F)	APG202: 0-10 mm (0-0.39 in) APG203: 0-12 mm (0-0.47 in) ASG102: 0-12 mm (0-0.47 in) ASG203: 0-19 mm (0-0.75 in)	APG202 APG203 ASG102 ASG203
APG203.22	056-163-822	Flat	Smooth Rubber	38 mm (1.5 in)	58 mm (2.3 in)	0° C (32° F) to 50° C (122° F)	APG202: 0-10 mm (0-0.39 in) APG203: 0-12 mm (0-0.47 in) ASG102: 0-12 mm (0-0.47 in) ASG203: 0-19 mm (0-0.75 in)	APG202 APG203 ASG102 ASG203
APG203.23	056-163-823	Flat	Line contact steel R4.75mm (0.187 in)	13 mm (0.5 in)	58 mm (2.3 in)	-40° C (-40° F) to 200° C (400° F)	APG202: 0-10 mm (0-0.39 in) APG203: 0-12 mm (0-0.47 in) ASG102: 0-12 mm (0-0.47 in) ASG203: 0-19 mm (0-0.75 in)	APG202 APG203 ASG102 ASG203

(continued next page...)

Tension Faces

APG202 & APG203 and ASG102 & ASG203 Grip Optional Faces (continued)

Model	Part Number	Profile	Surface	Height	Width	Temperature Range	Specimen Range	Compatible Grip Model
APG203.24	056-163-824	Flat	Grab Test Steel	38 mm (1.5 in), contact area 25mm (1.0 in)	58 mm (2.3 in), contact area 38mm (1.5 in)	-40° C (-40° F) to 200° C (400° F)	APG202: 0-10 mm (0-0.39 in) APG203: 0-12 mm (0-0.47 in) ASG102: 0-12 mm (0-0.47 in) ASG203: 0-19 mm (0-0.75 in)	APG202 APG203 ASG102 ASG203
APG203.25	056-163-825	Flat	Smooth Rubber	12 mm (0.5 in)	25 mm (1.0 in)	0° C (32° F) to 50° C (122° F)	APG202: 0-10 mm (0-0.39 in) APG203: 0-12 mm (0-0.47 in) ASG102: 0-12 mm (0-0.47 in) ASG203: 0-19 mm (0-0.75 in)	APG202 APG203 ASG102 ASG203
APG203.26	056-163-826	Flat	Smooth rubber/ line contact R4.75mm (0.187 in)	25 mm (1.0 in)	25 mm (1.0 in)	0° C (32° F) to 50° C (122° F)	APG202: 0-10 mm (0-0.39 in) APG203: 0-12 mm (0-0.47 in)	APG202 APG203
APG203.27	056-163-827	Flat	Smooth rubber/ line contact R4.75mm (0.187 in)	38 mm (1.5 in)	58 mm (2.3 in)	0° C (32° F) to 50° C (122° F)	APG202: 0-10 mm (0-0.39 in) APG203: 0-12 mm (0-0.47 in)	APG202 APG203
APG203.28	056-163-828	Flat	Diamond Tip Steel	25 mm (1.0 in)	150 mm (5.9 in)	-40° C (-40° F) to 200° C (400° F)	APG202: 0-10 mm (0-0.39 in) APG203: 0-12 mm (0-0.47 in)	APG202 APG203
APG203.29	056-163-829	Flat	Smooth rubber/ line contact R2.5mm (0.098 in)	25 mm (1.0 in)	25 mm (1.0 in)	-40° C (-40° F) to 200° C (400° F)	APG202: 0-10 mm (0-0.39 in) APG203: 0-12 mm (0-0.47 in)	APG202 APG203
APG203.30	056-163-830	Flat	Smooth Rubber	25 mm (1.0 in)	150 mm (5.9 in)	0° C (32° F) to 50° C (122° F)	APG202: 0-10 mm (0-0.39 in) APG203: 0-12 mm (0-0.47 in)	APG202 APG203
APG203.31	056-163-832	Flat	Smooth Rubber	25 mm (1.0 in)	100 mm (3.9 in)	0° C (32° F) to 50° C (122° F)	APG202: 0-10 mm (0-0.39 in) APG203: 0-12 mm (0-0.47 in)	APG202 APG203

ASG503 & ASG104 Grip Optional Faces

Model	Part Number	Profile	Surface	Height	Width	Temperature Range	Specimen Range	Compatible Grip(s)
ASG104.01	056-163-901	Flat	Smooth Steel	50 mm (2.0 in)	75 mm (3.0 in)	-40° C (-40° F) to 200° C (400° F)	0-25 mm (0-1.0 in)	ASG503
ASG104.02	056-163-902	Flat	Corrugated Steel	50 mm (2.0 in)	75 mm (3.0 in)	-40° C (-40° F) to 200° C (400° F)	0-25 mm (0-1.0 in)	ASG503 ASG104
ASG104.03	056-163-903	Flat	Serrated Steel	50 mm (2.0 in)	75 mm (3.0 in)	-40° C (-40° F) to 200° C (400° F)	0-25 mm (0-1.0 in)	ASG503 ASG104
ASG104.04	056-163-904	Flat	Diamond Tip Steel	50 mm (2.0 in)	75 mm (3.0 in)	-40° C (-40° F) to 200° C (400° F)	0-25 mm (0-1.0 in)	ASG503 ASG104
ASG104.05	056-163-905	Flat	Matte Rubber	50 mm (2.0 in)	75 mm (3.0 in)	0° C (32° F) to 50° C (122° F)	0-25 mm (0-1.0 in)	ASG503 ASG104
ASG104.06	056-163-906	Flat	Corrugated Rubber	50 mm (2.0 in)	75 mm (3.0 in)	0° C (32° F) to 50° C (122° F)	0-25 mm (0-1.0 in)	ASG503 ASG104
ASG104.07	056-163-907	Flat	Smooth Rubber	50 mm (2.0 in)	75 mm (3.0 in)	0° C (32° F) to 50° C (122° F)	0-25 mm (0-1.0 in)	ASG503 ASG104
ASG104.08	056-163-908	Flat	Line contact steel R4.75mm (0.187 in)	20 mm (0.8 in)	75 mm (3.0 in)	-40° C (-40° F) to 200° C (400° F)	0-25 mm (0-1.0 in)	ASG503 ASG104
ASG104.09	056-163-909	Flat	Grab Test Steel	50 mm (2.0 in), contact area 25mm (1.0 in)	75 mm (3.0 in), contact area 25mm (1.0 in)	-40° C (-40° F) to 200° C (400° F)	0-25 mm (0-1.0 in)	ASG503 ASG104
ASG104.10	056-163-910	Flat	Line rubber/ line contact R4.75mm (0.187 in)	50 mm (2.0 in)	75 mm (3.0 in)	0° C (32° F) to 50° C (122° F)	0-25 mm (0-1.0 in)	ASG503 ASG104

Tension Inserts

FLA105B Grip Optional Inserts

Model	Part Number	Profile	Temperature Range	Specimen Range	Compatible Grip Model
FLA105B.01	100-258-717	Bolt	0° C (32° F) to 50° C (122° F)	M4	FLA105B
FLA105B.02	100-258-718	Bolt	0° C (32° F) to 50° C (122° F)	M5	FLA105B
FLA105B.03	100-258-719	Bolt	0° C (32° F) to 50° C (122° F)	M6	FLA105B
FLA105B.04	100-258-720	Bolt	0° C (32° F) to 50° C (122° F)	M8	FLA105B
FLA105B.05	100-258-721	Bolt	0° C (32° F) to 50° C (122° F)	M10	FLA105B
FLA105B.06	100-258-722	Bolt	0° C (32° F) to 50° C (122° F)	M12	FLA105B
FLA105B.07	100-258-723	Nut	0° C (32° F) to 50° C (122° F)	M4	FLA105B
FLA105B.08	100-258-724	Nut	0° C (32° F) to 50° C (122° F)	M5	FLA105B
FLA105B.09	100-258-725	Nut	0° C (32° F) to 50° C (122° F)	M6	FLA105B
FLA105B.10	100-258-726	Nut	0° C (32° F) to 50° C (122° F)	M8	FLA105B
FLA105B.11	100-258-727	Nut	0° C (32° F) to 50° C (122° F)	M10	FLA105B
FLA105B.12	100-258-728	Nut	0° C (32° F) to 50° C (122° F)	M12	FLA105B

FLA305B Grip Optional Inserts

FLA305A.00	100-456-909	Adapter	0° C (32° F) to 50° C (122° F)	Adapter to FLA105B inserts	FLA305B
FLA305A.01	100-456-956	Bolt	0° C (32° F) to 50° C (122° F)	M12x1.75	FLA305A
FLA305A.02	100-456-958	Bolt	0° C (32° F) to 50° C (122° F)	M16x2	FLA305A
FLA305A.03	100-456-960	Bolt	0° C (32° F) to 50° C (122° F)	M20x2.5	FLA305A
FLA305A.04	100-456-962	Bolt	0° C (32° F) to 50° C (122° F)	M24x3	FLA305A
FLA305A.05	100-456-963	Bolt	0° C (32° F) to 50° C (122° F)	1/2-13	FLA305A
FLA305A.06	100-456-964	Bolt	0° C (32° F) to 50° C (122° F)	5/8-11	FLA305A
FLA305A.07	100-456-965	Bolt	0° C (32° F) to 50° C (122° F)	3/4-10	FLA305A

FLA605B Grip Optional Inserts

FLA605B.01	100-534-774	Bolt	0° C (32° F) to 50° C (122° F)	M20	FLA605B
FLA605B.02	100-534-775	Bolt	0° C (32° F) to 50° C (122° F)	M22	FLA605B
FLA605B.03	100-534-776	Bolt	0° C (32° F) to 50° C (122° F)	M24	FLA605B
FLA605B.04	100-534-777	Bolt	0° C (32° F) to 50° C (122° F)	M27	FLA605B

Controllers/Supply

MTS Model 685 self-contained, Hydraulic Grip Supplies have been engineered for both performance and ease of use.

Standard Features Include:

- » Directional control valve for each grip
- » Center valve detent, allowing unparalleled control over gripping
- » Continuous positive pressure design, providing high pressure stability over the entire operating range
- » Separate flow control valve for control of grip engagement speed
- » Independent grip circuits eliminate crosstalk
- » Easy to maintain and service
- » Accommodate a wide range of electrical connections

Model 685.10 and Model 685.22 Standalone Hydraulic Grip Supplies

The 685.22 and 685.10 units feature a self-contained hydraulic pump, a 0.75 kW (1 hp) electric motor, a 11.3 l (3 gal) reservoir, a 10-micron absolute return line filter, and hoses for connection to grips. These units are furnished with individual directional control valves for upper and lower grips. The grip supplies use a special hydraulic fluid which allows the grips to be used in environmental chambers at elevated temperatures. They are designed to run continuously, which results in good pressure stability and easy adjustment of the output pressure. Grip closure rate is also adjustable. Since the grip supplies are self-contained systems, they allow the use of hydraulic grips on non-hydraulic test systems.



Controller/Supply

Model 685 Hydraulic Grip Controller/Supply

- » Required for proper operation of Model 647 Hydraulic Wedge Grips
- » Provide precise upper and lower grip clamp/release control, pressure control and rate adjustment
- » Enable tight control of highly uniform and consistent clamping forces
- » Intuitive, easy-to-use control interface facilitate streamlined test setup
- » Special hydraulic fluid allows the grips to be used in environmental chambers at elevated temperatures
- » Self-contained design allows for the use of hydraulic grips on non-hydraulic test systems

Specifications

Model	685.10E-05	685.10E-06	685.10E-07	685.10E-08
Part Number	057-509-601	057-509-602	057-509-603	057-509-604
Compatible Grip Model	647.25A, 647.50A	647.25A, 647.50A	647.25A, 647.50A	647.25A, 647.50A
Output Pressure	10 - 70 MPa (1500 to 10,000 psi)	10 - 70 MPa (1500 to 10,000 psi)	10 - 70 MPa (1500 to 10,000 psi)	10 - 70 MPa (1500 to 10,000 psi)
Temperature Rating (Controller)	5° C (41° F) to 50° C (122° F)	5° C (41° F) to 50° C (122° F)	5° C (41° F) to 50° C (122° F)	5° C (41° F) to 50° C (122° F)
Hydraulic Hose Diameter	6.35 mm (0.25 in)	6.35 mm (0.25 in)	6.35 mm (0.25 in)	6.35 mm (0.25 in)
Temperature Rating (Hose)	-40° C (-40° F) to 177° C (350° F)	-40° C (-40° F) to 177° C (350° F)	-40° C (-40° F) to 177° C (350° F)	-40° C (-40° F) to 177° C (350° F)
Input Power	115 V, 60 Hz (single phase)	100-115 V, 50 Hz (single phase)	205-230 V, 60 Hz (single phase)	200-240 V, 50 Hz (single phase)
Power Rating	0.75 kW	0.75 kW	0.75 kW	0.75 kW
Height	914.4 mm (36.0 in)	914.4 mm (36.0 in)	914.4 mm (36.0 in)	914.4 mm (36.0 in)
Width	444.5 mm (17.5 in)	444.5 mm (17.5 in)	444.5 mm (17.5 in)	444.5 mm (17.5 in)
Depth	431.8 mm (17.0 in)	431.8 mm (17.0 in)	431.8 mm (17.0 in)	431.8 mm (17.0 in)
Weight	76 kg (170 lb)	76 kg (170 lb)	76 kg (170 lb)	76 kg (170 lb)

Specifications

Model	685.22D-05	685.22D-06	685.22D-07	685.22D-08
Part Number	057-598-001	057-598-002	057-598-003	057-598-004
Compatible Grip Model	647.02B, 647.10A, FYD305, FYD605, FDYA504, FDYB105	647.02B, 647.10A, FYD305, FYD605, FDYA504, FDYB105	647.02B, 647.10A, FYD305, FYD605, FDYA504, FDYB105	647.02B, 647.10A, FYD305, FYD605, FDYA504, FDYB105
Output Pressure	0.7 - 20.7 MPa (100 - 3000 psi)	0.7 - 20.7 MPa (100 - 3000 psi)	0.7 - 20.7 MPa (100 - 3000 psi)	0.7 - 20.7 MPa (100 - 3000 psi)
Temperature Rating (Controller)	5° C (41° F) to 50° C (122° F)	5° C (41° F) to 50° C (122° F)	5° C (41° F) to 50° C (122° F)	5° C (41° F) to 50° C (122° F)
Hydraulic Hose Diameter	6.35 mm (0.25 in)	6.35 mm (0.25 in)	6.35 mm (0.25 in)	6.35 mm (0.25 in)
Temperature Rating (Hose)	-40° C (-40° F) to 177° C (350° F)	-40° C (-40° F) to 177° C (350° F)	-40° C (-40° F) to 177° C (350° F)	-40° C (-40° F) to 177° C (350° F)
Input Power	115 V, 60 Hz (single phase)	100-115 V, 50 Hz (single phase)	208-230 V, 60 Hz (single phase)	200-240 V, 50 Hz (single phase)
Power Rating	0.75 kW	0.75 kW	0.75 kW	0.75 kW
Height	914.4 mm (36.0 in)	914.4 mm (36.0 in)	914.4 mm (36.0 in)	914.4 mm (36.0 in)
Width	444.5 mm (17.5 in)	444.5 mm (17.5 in)	444.5 mm (17.5 in)	444.5 mm (17.5 in)
Depth	431.8 mm (17.0 in)	431.8 mm (17.0 in)	431.8 mm (17.0 in)	431.8 mm (17.0 in)
Weight	76 kg (170 lb)	76 kg (170 lb)	76 kg (170 lb)	76 kg (170 lb)

Controller/Supply

MTS Advantage Pneumatic Grip Controller/Supply

- » Required for proper operation of MTS Advantage Pneumatic Grips.
- » Provides precise control of open/close functions, air pressure regulation and flow
- » Magnetic-mount handset or optional footswitch that makes specimen loading hassle-free



APC1850

MTS Fundamental Pneumatic Grip Controller/Supply

- » Required for proper operation of MTS Fundamental Pneumatic Bollard and Vise Grips
- » Provides precise control of open/close functions, air pressure regulation and flow



FPC2850

Specifications

Model	APC1850	FPC2850
Part Number	100-393-631	100-416-592
Grip Actuation Type	MTS Advantage Single Action Pneumatic	MTS Fundamental Dual Action Pneumatic
Recommended Output Pressure	0.27 - 0.55 MPa (40 - 80 psi)	0.27 - 0.55 MPa (40 - 80 psi)
Temperature Rating (Controller)	5° C (41° F) to 40° C (104° F)	5° C (41° F) to 40° C (104° F)
Air Tubing Diameter	6mm	6 mm
Temperature Rating (Tubing)	-170° C (-275° F) to 260° C (500° F)	-170° C (-275° F) to 260° C (500° F)
Input Power	100-240VAC, 50/60 Hz (single phase)	100-240VAC, 50/60 Hz (single phase)
Power rating	5.5 W	5.5 W
Height	330 mm (13.0 in)	330 mm (13.0 in)
Width	127 mm (5.0 in)	127 mm (5.0 in)
Depth	210 mm (8.3 in)	210 mm (8.3 in)
Weight	7 kg (15.4 lb)	7 kg (15.4 lb)

Grip Controller/Supply Options

Model	Part Number	Handswitch	Footswitch	Air Filter Assembly
APC1850	100-393-631	100-393-629	100-393-630	100-041-199
FPC2850	100-416-592	100-393-629	100-393-630	100-041-199

Compression Platens

Model 643 Compression Platens

- » High-performance compression platens designed for high- and low-temperature testing
- » Manufactured from case-hardened steel with hard chrome plating
- » Smooth faces with etched concentric rings enable the specimen to be centered visually for better test results
- » Spherical seat is available on upper platen for improved alignment and ensuring even pressure across the entire surface of the specimen
- » Platens are sold in pairs (upper and lower)
- » **Applications:** Compression testing of composites, elastomers, foam, packaging, plastics, wood, rock, concrete and other compressible materials



643.10A-01/-02

Monotonic Applications Only (stress calculations)

Applied Load	Minimum Specimen Diameter*	Stress Formula- Stress=Force/Area or $\sigma = F/A$
10 kN	4.3 mm (0.17 in)	$\sigma = 689 \text{ MPa}$
50 kN	9.6 mm (0.38 in)	$F = \text{Force (in Newtons)}$
100 kN	13.7 mm (0.54 in)	$A = \text{Area of specimen at platen contact (in Meter}^2\text{)}$
300 kN	23.6 mm (0.93 in)	
600 kN	33.3 mm (1.31 in)	

*Example of Minimum Specimen Diameter Calculation for Applied Loads

Specifications

Model	643.06A-01/-02	643.06A-03/-04	643.10A-01/-02	643.10A-03/-04
Part Number	100-024-676	100-024-675	100-024-678	100-024-677
Platen Type	Fixed/Spherical Steel Platen	Fixed/Fixed Steel Platen	Fixed/Spherical Steel Platen	Fixed/Fixed Steel Platen
Force Capacity (Stress)	689 MPa (100,000 psi)	689 MPa (100,000 psi)	689 MPa (100,000 psi)	689 MPa (100,000 psi)
Upper Platen Weight	1.45 kg (3.2 lbs)	0.91 kg (2 lbs)	5.22 kg (11.5 lbs)	3.4 kg (7.5 lbs)
Temperature Rating	-129° C (-200° F) to 177° C (350° F)	-129° C (-200° F) to 177° C (350° F)	-129° C (-200° F) to 177° C (350° F)	-129° C (-200° F) to 177° C (350° F)
Attachment Type	D	D	D	D
Combined Upper/Lower Platen Height	208 mm (8.2 in)	184 mm (7.2 in)	271 mm (10.7 in)	242 mm (9.5 in)
Platen Diameter	63.5 mm (2.5 in)	63.5 mm (2.5 in)	101 mm (4 in)	101 mm (4 in)

Specifications

Model	643.15A-01/-02	643.15A-03/-04	643.20A-01/-02	643.20A-03/-04	643.30A-01/-02	643.30A-03/-04
Part Number	100-024-680	100-024-679	100-215-231	100-215-230	100-024-682	100-024-681
Platen Type	Fixed/Spherical Steel Platen	Fixed/Fixed Steel Platen	Fixed/Spherical Steel Platen	Fixed/Fixed Steel Platen	Fixed/Spherical Steel Platen	Fixed/Fixed Steel Platen
Force Capacity (Stress)	689 MPa (100,000 psi)	689 MPa (100,000 psi)	689 MPa (100,000 psi)	689 MPa (100,000 psi)	689 MPa (100,000 psi)	689 MPa (100,000 psi)
Upper Platen Weight	16.78 kg (37 lbs)	8.17 kg (18 lbs)	38.33 kg (84.5 lbs)	17.74 kg (39.1 lbs)	124.7 kg (275 lbs)	59 kg (130 lbs)
Temperature Rating	-129° C (-200° F) to 177° C (350° F)	-129° C (-200° F) to 177° C (350° F)	-129° C (-200° F) to 177° C (350° F)	-129° C (-200° F) to 177° C (350° F)	-129° C (-200° F) to 177° C (350° F)	-129° C (-200° F) to 177° C (350° F)
Attachment Type	D	D	D	D	D	D
Combined Upper/Lower Platen Height	307.5 mm (12.1 in)	249 mm (9.8 in)	355 mm (14 in)	274 mm (10.8 in)	450 mm (17.7 in)	336 mm (13.2 in)
Platen Diameter	152 mm (6 in)	152 mm (6 in)	203 mm (8 in)	203 mm (8 in)	304 mm (12 in)	304 mm (12 in)

Compression Platens

MTS Fundamental Steel Compression Platens

- » Affordable steel compression platens designed for accurate testing with medium to higher force load cells
- » Precision-ground, hardened surfaces enhance platen durability
- » Specimen centering grooves, anti-rotation features and integrated alignment pins enhance test accuracy and repeatability
- » Platens are sold in pairs (upper and lower)
- » **Applications:** Compression testing of elastomers, foams, packaging, plastics, wood, and other compressible materials



FYA204A



FYB204A



FYA204A



FYB204A



FYA105A



FYC105A



FYB305A



FYC305A



FYA105A



FYC105A



FYB305A



FYC305A

Specifications

Model	FYA204A	FYB204A	FYA105A	FYC105A	FYB305A	FYC305A
Part Number	100-231-407	100-231-411	100-231-406	100-231-413	100-257-355	100-257-356
Platen Type	Fixed/Fixed Steel Platen	Fixed/Fixed Steel Platen	Fixed/Fixed Steel Platen	Fixed/Fixed Steel Platen	Fixed/Fixed Steel Platen	Fixed/Fixed Steel Platen
Force Capacity	20 kN (4,500 lbf)	20 kN (4,500 lbf)	100 kN (22,480 lbf)	100 kN (22,480 lbf)	300 kN (66,450 lbf)	300 kN (66,450 lbf)
Minimum Specimen Diameter at Maximum Force Capacity	5 mm (0.2 in)	5 mm (0.2 in)	5 mm (0.2 in)	5 mm (0.2 in)	15 mm (0.6 in)	15 mm (0.6 in)
Upper Platen Weight	1.491 kg (3.3 lbs)	3.433 kg (7.6 lbs)	2.434 kg (5.4 lbs)	6.637 kg (14.6 lbs)	8.9 kg (19.6 lbs)	12 kg (26.5 lbs)
Temperature Rating	-50° C (-58° F) to 150° C (302° F)	-50° C (-58° F) to 150° C (302° F)	-50° C (-58° F) to 150° C (302° F)	-50° C (-58° F) to 150° C (302° F)	-50° C (-58° F) to 150° C (302° F)	-50° C (-58° F) to 150° C (302° F)
Attachment Type	D	D	D	D	E	E
Combined Upper/ Lower Platen Height	156 mm (6.1 in)	192 mm (7.6 in)	202 mm (8 in)	202 mm (8 in)	320 mm (12.6 in)	320 mm (12.6 in)
Platen Diameter	100 mm (3.9 in)	150 mm (5.9 in)	100 mm (3.9 in)	200 mm (7.9 in)	150 mm (5.9 in)	200 mm (7.9 in)

Compression Platens

MTS Fundamental Aluminum Compression Platens

- » Affordable lightweight aluminum compression platens designed for accurate testing with lower force load cells
- » Specimen centering grooves, anti-rotation features and integrated alignment pins enhance test accuracy and repeatability
- » Platens are sold in pairs (upper and lower)
- » **Applications:** Compression testing of elastomers, foams, sintered materials and components, plastics, wood, and other highly compressible materials



Specifications

Model	FYA502A	FYB502A
Part Number	100-231-408	100-231-412
Platen Type	Fixed/Fixed Aluminum Platen	Fixed/Fixed Aluminum Platen
Force Capacity	0.5 kN (112 lbf)	0.5 kN (112 lbf)
Minimum Specimen Diameter at Maximum Force Capacity	5 mm (0.2 in)	5 mm (0.2 in)
Upper Platen Weight	0.28 kg (0.6 lbs)	0.548 kg (1.2 lbs)
Temperature Range	-50° C (-58° F) to 100° C (212° F)	-50° C (-58° F) to 100° C (212° F)
Attachment Type	D	D
Combined Upper/Lower Platen Height	156 mm (6.1 in)	156 mm (6.1 in)
Platen Width	50 mm (2 in)	100 mm (3.9 in)

MTS Fundamental Square Compression Platens

- » Affordable square compression platens
- » Durable alloy tool steel construction with reliable surface hardness
- » Easily center specimen loading with the round or cross-line scales
- » Platens are sold in pairs (upper and lower)
- » **Applications:** Compression testing of foams packaging materials, ring stiffness of pipes and other materials



DL07589.01

Specifications

Model	DL07589.01
Part Number	100-302-770
Platen Type	Fixed/Fixed Steel Platen
Force Capacity	200 kN (45,000 lbf)
Minimum Specimen Diameter at Maximum Force Capacity	22 mm (0.9 in)
Upper Platen Weight	60.2 kg (133 lbs)
Temperature Range	0° C (32° F) to 50° C (122° F)
Attachment Type	E
Combined Upper/Lower Platen Height	310 mm (12.2 in)
Platen Width	450 mm (17.7 in)
Platen Depth	450 mm (17.7 in)

Bend Fixtures

MTS Model 642 Three & Four Point Bend Fixtures

- » MTS three & four point bend fixtures feature a modular design that accommodates a variety of testing configurations
- » Flexible configurations provide either a region of constant stress or a line of maximum stress
- » Precision machined rollers are made from corrosion-resistant hardened steel
- » Easy-to-use, permanently attached scales for equal positioning of the rollers.
- » Adjustable spans feature Metric and US Customary scales
- » All models can be used for both 3- and 4-point tests
- » Hardened rollers ensure test result accuracy by reducing undesirable loading and frictional forces on the specimen
- » Loading & supporting rollers are included
- » **Applications:** Flexural (bend) testing of metals, composites, plastics, and other materials
- » See page 49 for roller options



Specifications

Model	642.001A-02	642.001-SST
Part Number	100-033-663	100-201-458
Fixture Type	3 & 4 Point Bend	Stainless Steel 3 & 4 Point
Force Capacity	1 kN (200 lbf)	1 kN (200 lbf)
Upper Grip Weight	3 Point- 0.045 kg (0.1 lbs) 4 Point- 0.11 kg (0.24 lbs)	3 Point- 0.13 kg (0.28 lbs) 4 Point- 0.32 kg (0.7 lbs)
Temperature Rating	-59° C (-75° F) to 120° C (250° F)	-59° C (-75° F) to 120° C (250° F)
Attachment Type	C	C
Combined Upper/Lower Fixture Height	3 Point- 140 mm (5.5 in) 4 Point- 148 mm (5.8 in)	3 Point- 140 mm (5.5 in) 4 Point- 148 mm (5.8 in)
Fixture Width	75.2 mm (2.96 in)	75.2 mm (2.96 in)
Contact Radius Type	Rolling	Rolling
Loading Span (4 point) 0.5, 1 mm radius	4-15.4 mm (0.16-0.6 in)	4-15.4 mm (0.16-0.6 in)
Loading Span (4 point) 1.5, 2, 2.5 mm radius	13.7-25 mm (.54-1 in)	13.7-25 mm (.54-1 in)
Supporting Span 0.5, 1 mm radius	4-50 mm (0.16-1.97 in)	4-50 mm (0.16-1.97 in)
Supporting Span 1.5, 2, 2.5 mm radius	13.7-59.7 mm (.54-2.35 in)	13.7-59.7 mm (.54-2.35 in)
Specimen Width	25 mm (1 in)	25 mm (1 in)

Integrated Specimen Interface

Loading Nose Radius	0.5 mm (0.02 in), 1 mm (0.04 in), 1.5 mm (0.06 in), 2 mm (0.08 in), 2.5 mm (0.1 in)	0.5 mm (0.02 in), 1 mm (0.04 in), 1.5 mm (0.06 in), 2 mm (0.08 in), 2.5 mm (0.1 in)
Supporting Nose Radius	0.5 mm (0.02 in), 1 mm (0.04 in), 1.5 mm (0.06 in), 2 mm (0.08 in), 2.5 mm (0.1 in)	0.5 mm (0.02 in), 1 mm (0.04 in), 1.5 mm (0.06 in), 2 mm (0.08 in), 2.5 mm (0.1 in)

Bend Fixtures

MTS Model 642 Three Point Bend Fixtures

- » MTS three point bend fixtures are designed to accommodate a variety of test configurations and standards
- » Model 642.01 can be used to meet ASTM D790, ASTM D7264, EN 2746, ISO 14125. The minimum nominal specimen thickness for the 4-point loading setup required by ISO 12125 Method B, is limited to 24 mm for smallest upper span.
- » Model 642.10 can be used to meet ASTM E399, ASTM D7264 and EN 2562. The minimum nominal specimen thickness for the 4-point loading setup required by ASTM D7264, is limited to 24 mm for smallest upper span.
- » Flexible configurations provide either a region of constant stress or a line of maximum stress
- » Adjustable spans feature Metric and US Customary scales
- » Rollers are sold separately
- » Rollers are sold in sets
- » **Applications:** Flexural (bend) testing of metals, composites, plastics, and other materials



642.01A-02



642.10B-02



642.25B-02

Specifications

Model	642.01A-02	642.01-SST	642.10B-02	642.25B-02
Part Number	100-024-684	100-203-454	100-024-686	100-024-688
Fixture Type	3 & 4 Point Bend	Stainless Steel 3 & 4 Point Bend	3 & 4 Point Bend	3 & 4 Point Bend
Force Capacity	12 kN (2,700 lbf)	12 kN (2,700 lbf)	125 kN (28,100 lbf)	300 kN (67,440 lbf)
Upper Fixture Weight	3 Point- 0.136 kg (0.3 lbs) 4 Point- 1.09 kg (2.4 lbs)	3 Point- 0.41 kg (0.9 lbs) 4 Point- 3.27 kg (7.2 lbs)	3 Point- 1.45 kg (3.2 lbs) 4 Point- 11.25 kg (24.8 lbs)	3 Point- 3.86 kg (8.5 lbs) 4 Point- 17.78 kg (39.2 lbs)
Temperature Rating	-129° C (-200° F) to 150° C (300° F)	-129° C (-200° F) to 177° C (350° F)	-129° C (-200° F) to 177° C (350° F)	-129° C (-200° F) to 177° C (350° F)
Attachment Type	D	D	D	D
Combined Upper/ Lower Fixture Height	3 Point- 264 mm (10.4 in) 4 Point- 325 mm (12.8 in)	3 Point- 264 mm (10.4 in) 4 Point- 325 mm (12.8 in)	3 Point- 343 mm (13.5 in) 4 Point- 442 mm (17.4 in)	3 Point- 488 mm (19.2 in) 4 Point- 696 mm (27.4 in)
Fixture Width	177.8 mm (7 in)	177.8 mm (7 in)	368.3 mm (14.5 in)	673.1 mm (26.5 in)
Contact Radius Type	Fixed	Fixed	Rolling	Rolling
Loading Span (4 point)	23.9-76.2 mm (0.94-3 in)	23.9-76.2 mm (0.94-3 in)	50.8-152.4 mm (2-6 in)	50.8-203.2 mm (2-8 in)
Supporting Span	23.9-152.4 mm (0.94-6 in)	23.9-152.4 mm (0.94-6 in)	38.1-304.8 mm (1.5-12 in)	78.7-609.6 mm (3.1-24 in)
Specimen Width	49.3 mm (1.94 in)	49.3 mm (1.94 in)	74.6 mm (2.94 in)	127 mm (5 in)

Bend Fixtures

Model 642.01 Optional Rollers

Model	Part Number	Compatible Fixtures	Roller Radius
642.01.01	051-284-601	642.01-02	φ2.5 mm
642.01.02	051-284-603	642.01-02	φ5 mm
642.01.03	051-284-602	642.01-02	φ0.125 in
642.01.04	051-284-604	642.01-02	φ0.25 in

Model 642.01-SST Optional Rollers

642.01.01SST	052-489-201	642.01-SST	φ2.5 mm
642.01.02SST	052-489-203	642.01-SST	φ5 mm
642.01.03SST	052-489-202	642.01-SST	φ0.125 in
642.01.04SST	052-489-204	642.01-SST	φ0.25 in

Model 642.10 Optional Rollers

642.10.01	049-578-501	642.10A-02	φ2.5 mm
642.10.02	049-578-503	642.10A-02	φ5 mm
642.10.03	049-578-505	642.10A-02	φ7.5 mm
642.10.04	049-578-507	642.10A-02	φ10 mm
642.10.05	049-578-509	642.10A-02	φ12.5 mm
642.10.06	049-578-502	642.10A-02	φ0.125 in
642.10.07	049-578-510	642.10A-02	φ0.1875 in
642.10.08	049-578-504	642.10A-02	φ0.25 in
642.10.09	049-578-506	642.10A-02	φ0.375 in
642.10.10	049-578-508	642.10A-02	φ0.50 in

Model 642.25 Optional Rollers

642.25.01	050-875-202	642.25B-02	φ10 mm
642.25.02	050-875-204	642.25B-02	φ15 mm
642.25.03	050-875-207	642.25B-02	φ20 mm
642.25.04	050-875-209	642.25B-02	φ25 mm
642.25.05	050-875-201	642.25B-02	φ0.375 in
642.25.06	050-875-203	642.25B-02	φ0.50 in
642.25.09	050-875-208	642.25B-02	φ0.875 in

Note: Consult MTS Application Engineer for custom size radius and force capacity

Bend Fixtures

MTS Fundamental Three Point Bend Fixtures

- » Affordable three point bend fixtures designed to support a wide variety of tests
- » Flexible configurations provide either a region of constant stress or a line of maximum stress
- » Precision machined rollers are made from corrosion-resistant hardened steel
- » Adjustable spans feature metric scales
- » **Applications:** Flexural (bend) testing of metals, composites, plastics, and other materials



Specifications

Model	FWA104A	FWA105A	FWA305A	FWA605
Part Number	100-231-417	100-231-418	100-258-158	100-504-190
Fixture Type	3 Point Bend Fixture	3 Point Bend Fixture	3 Point Bend Fixture	3 Point Bend Fixture
Force Capacity	10 kN (2,248 lbf)	100 kN (22,480 lbf)	300 kN (67,440 lbf)	600 kN (134,885 lbf)
Upper Fixture Weight	0.6 kg (1.32 lbs)	2 kg (4.4 lbs)	5.67 kg (12.5 lbs)	12 kg (26.5 lbs)
Temperature Rating	-50° C (-58° F) to 150° C (302° F)	-50° C (-58° F) to 150° C (302° F)	-50° C (-58° F) to 150° C (302° F)	0° C (32° F) to 50° C (122° F)
Attachment Type	D	D	E	F
Combined Upper/Lower Fixture Height	268 mm (10.6 in)	376 mm (14.8 in)	543 mm (21.4 in)	735 mm (28.9 in)
Fixture Width	226 mm (8.9 in)	464 mm (18.3 in)	561 mm (22.1 in)	186 mm (7.3 in)

Integrated Specimen Interface

Contact Radius Type	Fixed	Rolling	Rolling	Rolling
Loading Nose Radius	φ2 mm (0.08 in), 5 mm (0.2 in)	φ10 mm (0.39 in)	φ15 mm (0.59 in)	φ15 mm (0.59 in)
Supporting Nose Radius	φ2 mm (0.08 in), 5 mm (0.2 in)	φ10 mm (0.39 in)	φ15 mm (0.59 in)	φ15 mm (0.59 in)
Loading Span	40-160 mm (1.6-6.3 in)	30-360 mm (1.1-14.1 in)	30-340 mm (1.1-13.4 in)	60-370 mm (2.4-14.6 in)
Specimen Width	40 mm (1.6 in)	80 mm (3.1 in)	90 mm (3.5 in)	119 mm (4.7 in)

Bend Fixtures

MTS Fundamental Specialty Three Point Bend Fixtures

- » Affordable three point bend fixtures for more unique applications
- » Loading edge and supports can be changed to optional parts or customized designs
- » Adjustable stepless lower span on the support beam
- » The support and loading edges are constructed of alloy tool steel with reliable surface hardness and durability
- » The rollers can rotate to minimize errors caused by friction
- » Fast and accurate specimen positioning with centering device
- » **Applications:** Flexural (bend) testing of wood, metals, composites, plastics, and other materials

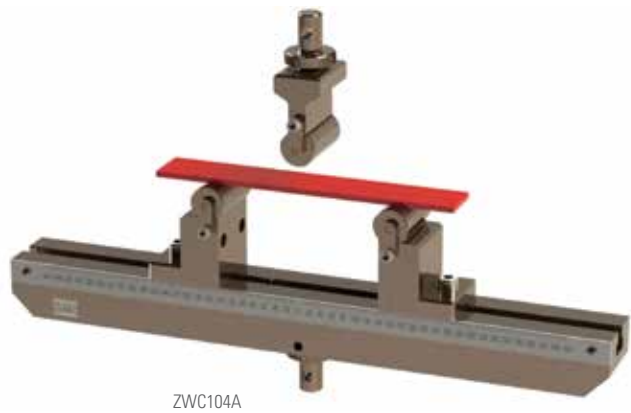

Specifications

Model	WA102A	ZWC104A	WA204A
Part Number	100-302-793	100-302-802	100-660-347
Fixture Type	3 Point Bend Fixture	3 Point Bend Fixture	3 Point Bend Fixture
Force Capacity	0.5 kN (112 lbf)	10 kN (2,248 lbf)	20 kN (4,500 lbf)
Upper Fixture Weight	0.28 kg (0.62 lbs)	1.1 kg (2.4 lb)	0.67 kg (1.5 lbs)
Temperature Rating	0° C (32° F) to 50° C (122° F)	0° C (32° F) to 50° C (122° F)	0° C (32° F) to 50° C (122° F)
Attachment Type	20	20	20
Combined Upper/Lower Fixture Height	187.5 mm (7.4 in)	300 mm (11.8 in)	277 mm (10.9 in)
Fixture Width	42 mm (1.6 in)	530 mm (20.9 in)	340 mm (13.4 in)

Integrated Specimen Interface

Contact Radius Type	Fixed	Rolling	Fixed
Loading Nose Radius	1.5 mm (0.06 in)	7.5 mm (0.3 in), 15 mm (0.6 in)	5 mm (0.2 in)
Supporting Nose Radius	1.5 mm (0.06 in)	7.5 mm (0.3 in), 15 mm (0.6 in)	2 mm (0.08 in), 5 mm (0.2 in)
Loading Span	10-100 mm (0.4-3.9 in)	30-400 mm (1.2-15.7 in)	20-200 mm (0.8-7.87 in)
Specimen Width	30 mm (1.2 in)	60 mm (2.3 in)	45 mm (1.8 in)

Specialty Fixtures

MTS Fundamental 5 kN Puncture Fixture

- » Affordable puncture fixture
- » Plunger and base specimen holder are included
- » plungers or clamping rings can be customized
- » **Applications:** Puncture resistance testing of plastic films, fabrics and other membrane materials

Specifications

Model	ZDPA503
Part Number	100-302-835
Fixture Type	Puncture Fixture
Force Capacity	5 kN (1,125 lbf)
Upper Fixture Weight	2.17 kg (4.8 lb)
Temperature Range	0° C (32° F) to 50° C (122° F)
Attachment Type	20
Combined Upper/Lower Fixture Height	180 mm (7.1 in)
Fixture Width	42 mm (1.7 in)

Integrated Specimen Interface

Plunger Cylinder	ø50 mm (2 in)
Plunger Lead Edge	2.5 mm (0.1in) edge radius
Clamping Ring	ø150 mm ID (5.9 in)



MTS Fundamental 90° Peel Fixture

- » Affordable 90° peel fixture designed with moveable X,Y table
- » Precision bearings maintain perpendicular axial alignment while measuring the force required to peel adhered material from a clamped-down substrate

- » Upper grip is not included.
- » **Applications:** Peel strength testing of flexible adhesive materials suitable for a variety of material testing standards including ASTM D1876, FINAT FTM1/2/3, and AFERA 4015 T4



Specifications

Model	FPF452
Part Number	100-170-762
Fixture Type	90° Peel
Force Capacity	0.45 kN (100 lbf)
Upper Fixture Weight	NA
Temperature Rating	0° C (32° F) to 50° C (122° F)
Attachment Type	D
Lower Fixture Height	140 mm (5.5 in)
Fixture Width	404 mm (15.9 in)
Specimen Travel (Parallel to travel)	152.4 mm (6 in)
Specimen Travel (Perpendicular to travel)	101.6 mm (4 in)

Integrated Specimen Interface

Length	165 mm (6.5 in)
Thickness	3.556 mm (0.140 in)
Width	12.7-95.3 mm (0.5-3.75 in)

Specialty Fixtures

MTS Fundamental Coefficient of Friction Fixture

- » Affordable coefficient of friction fixture
- » Pulley and string mechanism measures the force required to pull a friction sled over a material specimen
- » Suitable for a variety of material testing standards, including ASTM D1894 (plastic film), TAPPI T542 (paper and cardboard), TAPPI T549 (non-fibrous materials), and TAPPI T816 (corrugated).
- » Upper grip is not included.
- » **Applications:** Friction testing of plastic film, paper and cardboard, non-fibrous materials

Specifications

Model	FCF103
Part Number	100-087-526
Fixture Type	Coefficient of Friction
Force Capacity	1 kN (225 lbf)
Upper Fixture Weight	NA
Temperature Rating	0° C (32° F) to 50° C (122° F)
Attachment Type	D
Lower Fixture Height	112 mm (4.4 in)
Fixture Width	203 mm (8 in)

Integrated Specimen Interface

Length	279.4 mm (11 in)
Maximum Thickness	5 mm (0.2 in)
Width	152.4 mm (6 in)

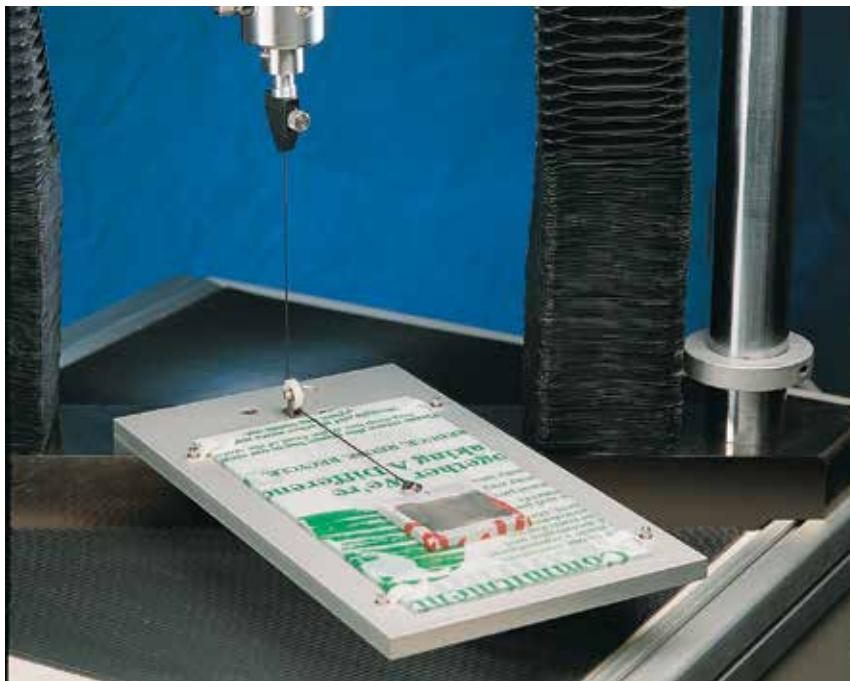

Bionix

Tension

Bionix Bollard Grips

- » Stainless steel “horn” style bollard grips are designed to reduce stress concentration on specimens and avoid grip-induced failures
- » Anti-rotation features and integrated alignment pins enhance test accuracy and repeatability
- » Passivated stainless steel – suitable for saline environmental baths
- » Grips are sold in pairs
- » Specimen interface (“face”) is integrated with each grip
- » **Applications:** Tensile testing of cords, filaments, fibers, fine wire and biomaterials

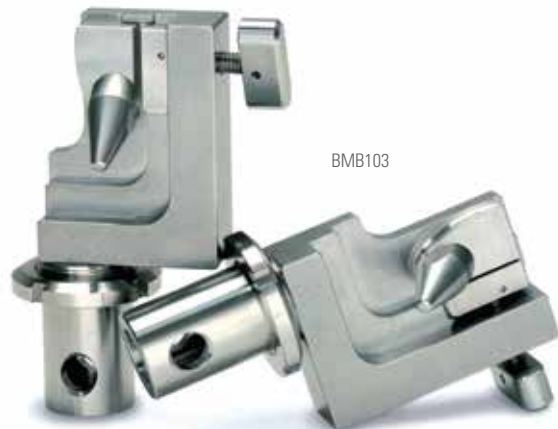

Specifications

Model	BMB103
Part Number	100-185-264
Grip Type	Stainless Steel Manual Bollard
Force Capacity	1 kN (225 lbf)
Upper Grip Weight	1.01 kg (2.2 lb)
Temperature Rating	-130° C (202° F) to 150° C (302° F)
Attachment Type	D
Combined Upper/Lower Grip Height	280 mm (11 in)
Grip Width	84 mm (3.3 in)

Integrated Specimen Interface

Profile	Flat
Surface	Smooth Steel
Specimen Range	0-3 mm (0-0.12 in)

Bionix Scissor Grips

- » Stainless steel scissor grips with self-tightening and self-aligning design
- » Anti-rotation features and integrated alignment pins enhance test accuracy and repeatability
- » Passivated stainless steel – suitable for saline environmental baths
- » Grips are sold in pairs
- » Specimen interface (“face”) is integrated with each grip
- » **Applications:** Tensile testing of irregular bio-materials, bone, cartilage, tendons, and replacement bio-medical components



Specifications

Model	BMS103
Part Number	100-181-625
Grip Type	Stainless Steel Manual Scissor
Force Capacity	1 kN (225 lbf)
Upper Grip Weight	0.85 kg (1.9 lb)
Temperature Rating	-130° C (-202° F) to 250° C (482° F)
Attachment Type	D
Combined Upper/Lower Grip Height	346 mm (13.6 in)
Grip Width	108 mm (4.3 in)

Integrated Specimen Interface

Profile	Round
Surface	Diamond Tip Steel
Height	16 mm (0.6 in)
Width	25 mm (1.2 in)
Specimen Range	0-10 mm (0-0.4 in)

Bionix

Tension

Bionix Roller Grips

- » Stainless steel roller grips with self-tightening and self-aligning design
- » Anti-rotation features and integrated alignment pins enhance test accuracy and repeatability
- » Passivated stainless steel – suitable for saline environmental baths
- » Grips are sold in pairs
- » Specimen interface (“face”) is integrated with each grip
- » **Applications:** Tensile testing of bandages, bio-textiles, diapers, synthetics, and flexible polymers



Specifications

Model	BMR103	BMR203	BMR503
Part Number	100-185-262	100-184-839	100-184-841
Grip Type	Stainless Steel Roller	Stainless Steel Roller	Stainless Steel Roller
Force Capacity	1 kN (225 lbf)	2 kN (550 lbf)	5 kN (1,124 lbf)
Upper Grip Weight	1.3 kg (2.9 lb)	1.42 kg (3.1 lb)	2.26 kg (5.0 lb)
Temperature Rating	-10° C (14° F) to 50° C (122° F)	-130° C (-202° F) to 250° C (482° F)	-130° C (-202° F) to 250° C (482° F)
Attachment Type	D	D	D
Combined Upper/Lower Grip Height	280 mm (11 in)	254 mm (10 in)	274 mm (10.8 in)
Grip Width	60 mm (2.3 in)	88 mm (3.5 in)	120 mm (4.7 in)

Integrated Specimen Interface

Surface	Rubber	Diamond Tip Steel	Diamond Tip Steel
Specimen Range	0-3 mm (0-0.1 in)	0-4 mm (0-0.2 in)	0-7 mm (0-0.3 in)
Maximum Width	50 mm (2.0 in)	50 mm (2.0 in)	75 mm (2.9 in)

Bionix

Tension

Bionix Spring Grips

- » Stainless steel spring grips with lightweight design for use with low-force load cells
- » Spring action follow-through accommodates specimen neckdown
- » Faces pivot for self-alignment and for reduced likelihood of breakage at the specimen/face contact
- » Force of jaw tips (jaws parallel): $32\text{ N} \pm 4.4\text{ N}$ ($7.2\text{ lbf} \pm 1.1\text{ lbf}$)
- » Passivated stainless steel – suitable for saline environmental baths
- » Grips are sold in pairs
- » Two grip assemblies, two spare springs, two spare wires for link pin retainers are included with grip set.
- » Specimen interface (“face”) is integrated with each grip
- » **Applications:** Low-force tensile testing as well as films, papers, textiles, and biomedical applications

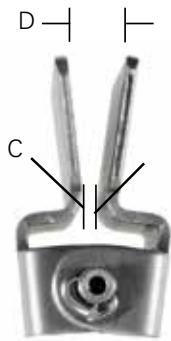

Model BMS10A,
fully open



Model BMS10A,
jaws parallel

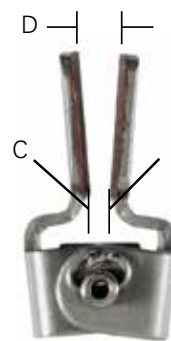

Model BMS10B,
(with rubber face),
fully open



Model BMS10B,
(with rubber face),
jaws parallel

Specifications

Model	BMS10A	BMS10B
Part Number	056-644-001	056-644-002
Grip Type	Stainless Steel Spring	Stainless Steel Spring
Force Capacity	0.003 kN (0.67 lbf)	0.01 kN (2.2 lbf)
Upper Grip Weight	0.078 kg (0.17 lbs)	0.078 kg (0.17 lbs)
Temperature Rating	-75° C (-103° F) to 200° C (392° F)	-75° C (-103° F) to 200° C (392° F)
Attachment Type	B	B
Combined Upper/Lower Grip Height	190 mm (7.5 in)	190 mm (7.5 in)
Grip Width	35 mm (15.9 in)	35 mm (15.9 in)

Integrated Specimen Interface

	Smooth Stainless Steel	Rubber Face
Surface	Smooth Stainless Steel	Rubber Face
Length	12.7 mm (0.5 in)	12.7 mm (0.5 in)
Specimen Range	0-2.6 mm (0-0.1 in)	0-2.6 mm (0-0.1 in)
Maximum Width	25 mm (1 in)	25 mm (1 in)
Span B	0.0	0.0
Span C	1.0 mm (0.039 in)	1.0 mm (0.039 in)
Span D	2.6 mm (0.103 in)	2.6 mm (0.103 in)

Bionix

Tension

Bionix Vise Grips

- » Stainless steel vise grips with a clamping screw design to tighten a vise
- » Anti-rotation features and integrated alignment pins enhance test accuracy and repeatability
- » Passivated stainless steel – suitable for saline environmental baths
- » Grips are sold in pairs
- » Specimen interface (“face”) is integrated with each grip
- » **Applications:** Tensile testing of plastic film, textile, sheet materials, bandages, bio-textiles, diapers, plastic films, packaging components and biomaterials in a fluid bath



Specifications

Model	BMV102	BMV203	BMV503
Part Number	100-186-411	100-174-783	100-186-413
Grip Type	Stainless Steel Manual Vise	Stainless Steel Manual Vise	Stainless Steel Manual Vise
Force Capacity	0.1 kN (22 lbf)	2 kN (450 lbf)	5 kN (1,124 lbf)
Upper Grip Weight	0.56 kg (1.23 lb)	1.0 kg (2.2 lb)	3.1 kg (6.8 lb)
Temperature Rating	-10° C (14° F) to 50° C (122° F)	-10° C (14° F) to 50° C (122° F)	-10° C (14° F) to 50° C (122° F)
Attachment Type	D	D	D
Combined Upper/Lower Grip Height	230 mm (9 in)	236 mm (9.3 in)	300 mm (11.8 in)
Grip Width	71.5 mm (2.8 in)	93 mm (3.7 in)	147 mm (5.8 in)

Integrated Specimen Interface

Profile	Flat	Flat	Flat
Surface	Rubber	Rubber	Rubber
Height	10 mm (0.4 in)	20 mm (0.8 in)	50 mm (2.0 in)
Width	10 mm (0.4 in)	65 mm (2.6 in)	80 mm (3.1 in)
Specimen Range	0-2 mm (0-0.08 in)	0-3.5 mm (0-0.14 in)	0-10 mm (0-0.4 in)

Bionix

Compression

Bionix Stainless Steel Compression Platens

- » Stainless steel compression platen designed for durability
- » Precision-ground, hardened surface design enhances platen durability
- » Specimen centering grooves, anti-rotation features and integrated alignment pins improve test accuracy and repeatability
- » Passivated stainless steel – suitable for saline environmental baths
- » Platens are sold in pairs (upper and lower)
- » **Applications:** Compression testing of irregular biomaterials, bone, cartilage, tendons, replacement bio-medical components



Specifications

Model	BCP104A	BCP104B	BCP104C
Part Number	100-182-229	100-182-227	100-203-455
Platen Type	Fixed/Fixed Stainless Steel Platen	Fixed/Fixed Stainless Steel Platen	Fixed/Fixed Stainless Steel Platen
Force Capacity	10 kN (2,250 lbf)	10 kN (2,250 lbf)	10 kN (2,250 lbf)
Minimum Specimen Diameter at Maximum Force Capacity	5 mm (0.2 in)	5 mm (0.2 in)	5 mm (0.2 in)
Upper Platen Weight	0.68 kg (1.5 lbs)	1.82 kg (4 lbs)	0.3 kg (0.66 lbs)
Temperature Range	-130° C (-202° F) to 250° C (482° F)	-130° C (-202° F) to 250° C (482° F)	-130° C (-202° F) to 250° C (482° F)
Attachment Type	D	D	M6 x 1
Combined Upper/Lower Platen Height	148 mm (5.9 in)	148 mm (5.9 in)	50 mm (2 in)
Platen Width	50 mm (2 in)	100 mm (3.9 in)	40 mm (1.6 in)

Bionix

Fluid Bath

Bionix EnviroBath

- » Supports saline and protein-based fluid baths to provide maximum flexibility
- » Easy set-up, operation and disassembly simplifies cleaning and maintenance
- » Highly reliable temperature control system enhances test accuracy
- » Accommodates the Bionix Grips and Fixtures portfolio to enable a broad variety of test specimens
- » Leak-proof access panels enable easy change out of accessories and specimens
- » Compatible with video or laser extensometers
- » **Applications:** Mechanical testing of medical device, biomaterial specimens in fluids heated to body temperatures



Bionix EnviroBath 1

General Specifications

Power (V AC, HZ, A)

US: 120 V AC, 50/60 Hz, 11 A

Europe: 240 V AC, 50 Hz, 10 A

Specifications

Model	Bionix EnviroBath 1	Bionix EnviroBath 6	Bionix EnviroBath 10
Part Number	Configurable	Configurable	Configurable
Volume	1 L (0.26 gal)	6 L (1.6 gal)	10 L (2.6 gal)
Force Capacity	2.4 kN (540 lbf)	2.4 kN (540 lbf)	10 kN (2248 lbf)
Temperature Rating	5° C (41° F) above ambient to 40° C (104° F)	5° C (41° F) above ambient to 40° C (104° F)	5° C (41° F) above ambient to 40° C (104° F)
Stability	±2° C (±3.6° F) at 37° C (98.6° F)	±2° C (±3.6° F) at 37° C (98.6° F)	±2° C (±3.6° F) at 37° C (98.6° F)
Internal Width	100 mm (4 in)	130 mm (5 in)	215 mm (8.5 in)
Internal Height	200 mm (8 in)	480 mm (19 in)	305 mm (12 in)
Internal Depth	56 mm (2.2 in)	100 mm (3.9 in)	150 mm (5.8 in)
External Width	180 mm (7 in)	205 mm (8 in)	295 mm (11.5 in)
External Height	295 mm (11.5 in)	575 mm (22.5 in)	395 mm (15.5 in)
External Depth	95 mm (3.65 in)	140 mm (5.5 in)	190 mm (7.4 in)

Bionix

Fluid Bath



Fluid Bath Options

Description	1 liter	6 liter	10 liter
Sprayer Option		√	√
Protein Based Fluid	√	√	√
Horizontal	√	√	√
Digital Temperature Monitor	√	√	√
Upper Pull Rod (SST)	√	√	√

Compatibility Matrix*

Grips and Fixtures	Page	1 liter	6 liter	10 liter
Bionix Vise Grips, 0.1 kN	57	√	√	√
Model 642.001 Bend Fixture (SST), 1 kN	47	√	√	√
Bionix Manual Thumb Vise Grip, 0.1 kN	24	√	√	√
Bionix Compression Platens, 40 mm	58	√	√	√
Bionix Spring Grips, 0.003 kN, 0.01 kN	56		√	√
Bionix Compression Platens, 50 mm	58		√	√
Bionix Vise Grips, 2 kN	57		√	√
Bionix Roller Grips, 1 kN	55		√	√
Model 642.01 Bend Fixture (SST), 12 kN	48			√
Bionix Compression Platens, 100 mm	58			√

Note: EnviroBath 10 is compatible with customer-supplied spinal fixture per ASTM F1717-01.

Some grips available in titanium. Contact MTS for additional information.

* Vertical Orientation

Composites

Modified Celanese Compression Loading Fixture

- » Celanese compression fixture is constructed from high-quality stainless steel
- » Design based on the University of Wyoming Modified Celanese Compression Test Fixture
- » Includes wedges with flame sprayed high friction surface
- » Requires compression platens for mounting (*purchased separately*)
- » **Applications:** Compression testing in accordance with ISO 14126 Method 1A



IITRI Compression Loading Fixture

- » IITRI compression fixture is constructed from high-quality stainless steel
- » Includes set of wedges to accommodate specimen thicknesses from 5.1 - 10.2 mm (0.2 - 0.4 in)
- » Wedges that support 0-5.1 mm (0-0.2 in) and 10.2-15.2 mm (0.4-0.6 in) specimen thicknesses are available on request.
- » Requires threaded adapters or compression platens for mounting (*purchased separately*)
- » **Applications:** Compression testing in accordance with ASTM D3410/D3410M and ISO 14126 Method 1B



Specifications

Model	CMP.001
Part Number	100-351-817
Fixture Type	Modified Celanese Compression Loading Fixture
Force Capacity	88 kN (20 kip)
Fixture Weight	7.3 kg (16 lbs)
Temperature Rating	-152° C (-240° F) to 318° C (600° F)
Attachment Type	N/A
Fixture Height	191 mm (7.5 in)
Fixture Width	89 mm (3.5 in)

Integrated Specimen Interface

Length	114.3 mm (4.5 in)
Specimen Range	3.8-6.35 mm (0.15-0.25 in)
Maximum Width	12.7 mm (0.5 in)

Specifications

Model	CMP.002
Part Number	100-351-818
Fixture Type	IITRI Compression Loading Fixture
Force Capacity	267 kN (60 kip)
Fixture Weight	36 kg (80 lbs)
Temperature Rating	-152° C (-240° F) to 318° C (600° F)
Attachment Type	M30 x 2
Fixture Height	356 mm (14 in)
Fixture Width	178 mm (7 in)

Integrated Specimen Interface

Length	140 mm (5.5 in)
Specimen Range	5.1-10.2 mm (0.2-0.4 in)
Maximum Width	25.4 mm (1 in)

Composites

Combined Loading Compression (CLC) Test Fixture

- » CLC compression fixture is constructed from high-quality stainless steel
- » Requires compression platens for mounting (*purchased separately*)
- » **Applications:** Compression testing in accordance with ASTM D6641/D6641M



CMP.003

Specifications

Model	CMP.003
Part Number	100-351-819
Fixture Type	Combined Loading Compression Fixture
Force Capacity	89 kN (20 kip)
Fixture Weight	6.8 kg (15 lbs)
Temperature Rating	-152° C (-240° F) to 318° C (600° F)
Attachment Type	NA
Fixture Height	140 mm (5.5 in)
Fixture Width	107 mm (4.2 in)

Integrated Specimen Interface

Length	140 mm (5.5 in)
Specimen Range	0-12.7 mm (0-0.5 in)
Maximum Width	25.4 mm (1 in)

V-Notched Rail Shear Test Fixture

- » V-Notched rail shear fixture is constructed from high-quality stainless steel
- » Requires threaded adapter for top and bottom mounting (*purchased separately*)
- » **Applications:** Shear testing in accordance with ASTM D7078/D7078M



CMP.004

Specifications

Model	CMP.004
Part Number	100-351-820
Fixture Type	V-Notched Rail Shear Fixture
Force Capacity	44 kN (10 kip)
Fixture Weight	7.7 kg (17 lbs)
Temperature Rating	-152° C (-240° F) to 318° C (600° F)
Mounting Thread Insert Sizes	1"-14
Fixture Height	165 mm (6.5 in)
Fixture Width	102 mm (4 in)

Integrated Specimen Interface

Maximum Length	76 mm (3 in)
Specimen Range	0-12.7 mm (0-0.5 in)
Maximum Width	55.6 mm (2.2 in)

Composites

V-Notched Beam (Iosipescu) Shear Fixture

- » V-Notched beam shear fixture is constructed from high-quality stainless steel
- » Includes adjustable wedges
- » Requires threaded adapter for top and compression platen for bottom mounting (*purchased separately*)
- » **Applications:** Shear testing in accordance with ASTM D5379/D5379M



CMP.005

Specifications

Model	CMP.005
Part Number	100-087-239
Fixture Type	V-Notched Beam Shear Fixture
Force Capacity	44 kN (10 kip)
Fixture Weight	6.8 kg (15 lbs)
Temperature Rating	-152° C (-240° F) to 318° C (600° F)
Mounting Thread Insert Sizes	1/2"-20
Fixture Height	115 mm (4.5 in)
Fixture: Width	153 mm (6 in)

Integrated Specimen Interface

Length	76 mm (3.0 in)
Specimen Range	0.76-12.7 mm (0.03-0.5 in)
Maximum Width	19.0 mm (0.75 in)

Short-Beam Strength Fixture

- » Short-beam strength fixture is constructed from high-quality stainless steel
- » Adjustable support span
- » Supports include specimen center tabs for accurate specimen alignment
- » Requires female clevis adapter or compression platen for top and threaded adapter or compression platen for bottom mounting (*purchased separately*)
- » **Applications:** Strength testing in accordance with ASTM D2344 (please contact MTS for fixture in accordance to ASTM D2344M)



CMP.006

Specifications

Model	CMP.006
Part Number	100-351-821
Fixture Type	Short-Beam Strength Fixture
Force Capacity	8.9 kN (2 kip)
Fixture Weight	6.8 kg (15 lbs)
Temperature Rating	-152° C (-240° F) to 318° C (600° F)
Top Mounting Male Clevis	12 mm (Type 0)
Fixture Height	290 mm (11.4 in)
Fixture Width	178 mm (7 in)
Loading Nose Radius	3.175 mm (0.125 in)
Supporting Nose Radius	1.588 mm (0.063 in)

Integrated Specimen Interface

Supporting Span	3.2-152 mm (0.125-6 in)
Maximum Thickness	50 mm (2 in)
Maximum Width	38 mm (1.5 in)

CMP.006 Optional Specimen Interfaces

Model	Part Number	Profile	Radius	Temperature Range
CMP.006.01	100-352-347	Loading Nose	5 mm (0.2 in)	-152° C (-200° F) to 318° C (600° F)
CMP.006.02	100-352-348	Supporting Nose	2 mm (0.08 in)	-152° C (-200° F) to 318° C (600° F)

Composites

Mixed Mode Bending Fixture

- » Mixed mode bend fixture is constructed from high-quality stainless steel and aluminum
- » Includes 5 sets of specimen hinges
- » Requires threaded adapter for top and compression platen for bottom mounting (*purchased separately*)
- » **Applications:** Flexure (bend) testing in accordance with ASTM D6671/D6671M



CMP.007

Specifications

Model	CMP.007
Part Number	100-351-822
Fixture Type	Mixed Mode Bending Fixture
Force Capacity	4.4 kN (1 kip)
Fixture Weight	7.3 kg (16 lbs)
Temperature Rating	-85° C (-120° F) to 122° C (250° F)
Top Mounting Threaded Stud Sizes	1/4"-28
Fixture Height	203 mm (8 in)
Fixture Width	254 mm (10 in)

Integrated Specimen Interface

Maximum Length	228 mm (9.0 in)
Maximum Thickness	6.35 mm (0.25 in)
Maximum Width	38 mm (1.5 in)

Open / Filled Hole Compression Fixture

- » Open / Filled hole compression fixture is constructed from high-quality stainless steel
- » Requires compression platens or hydraulic grips for mounting (*purchased separately*)
- » **Applications:** Compression testing in accordance with ASTM D6484, ASTM D6742 and BS 07260 (please contact MTS for fixture in accordance with ASTM D6484M and ASTM D6742M)

Note: Fixture thickness for gripping = 30 mm (1.18 in) + specimen thickness.



CMP.008

Specifications

Model	CMP.008
Part Number	100-351-823
Fixture Type	Open Hole Compression Fixture
Force Capacity	222 kN (50 kip)
Fixture Weight	6.8 kg (15 lbs)
Temperature Rating	-152° C (-240° F) to 318° C (600° F)
Attachment Type	N/A
Fixture Height	305 mm (12 in)
Fixture Width	76 mm (3 in)

Integrated Specimen Interface

Maximum Length	305 mm (12 in)
Specimen Range	12.7 mm (0.5)
Maximum Width	38 mm (1.5 in)

Composites

Compression After Impact Test Fixture

- » Compression after impact test fixture is constructed from high-quality stainless steel
- » Requires threaded adapter for top and compression platen for bottom mounting (*purchased separately*)
- » **Applications:** Compression testing in accordance with ASTM D7137 (please contact MTS for fixture in accordance with ASTM D7137M)



CMP.009

Specifications

Model	CMP.009
Part Number	100-351-824
Fixture Type	Compression After Impact Fixture
Force Capacity	222 kN (50,000 lbs)
Fixture Weight	16 kg (35 lbs)
Temperature Rating	-152° C (-240° F) to 318° C (600° F)
Mounting Thread	1/2"-13
Insert Sizes	
Fixture Height	198 mm (7.8 in)
Fixture Width	356 mm (14 in)

Integrated Specimen Interface

Length	152 mm (6 in)
Specimen Range	3.175-12.7 mm (0.125-0.5 in)
Width	102 mm (4 in)

Flatwise Plane Shear Fixture, Tensile Mode

- » Flatwise plane shear test fixture is constructed from high-quality stainless steel
- » Includes three sets of aluminum bonding plates
- » Requires threaded adapter for top and bottom mounting (*purchased separately*)
- » **Applications:** Shear testing in Tensile mode in accordance with ASTM C273/C273M and ASTM C394/C394M (Fatigue)



CMP.010

Specifications

Model	CMP.010
Part Number	100-204-294
Fixture Type	Flatwise Plane Shear Tensile Fixture
Force Capacity	89 kN (20 kip)
Fixture Weight	14.5 kg (32 lbs)
Temperature Rating	-152° C (-240° F) to 318° C (600° F)
Mounting Thread	1"-14
Insert Sizes	
Fixture Height	470 mm (18.5 in)
Fixture Width	76 mm (3 in)

Integrated Specimen Interface

Maximum Length	229 mm (9 in)
Specimen Range	6.3-19.1 mm (0.25-0.75 in)
Maximum Width	76 mm (3 in)

* Temperature Range of Aluminum Bonding Plates -85 to 122°C (-120 to 250°F)

Composites

Flatwise Plane Shear Fixture, Compression Mode

- » Flatwise plane shear test fixture is constructed from high-quality stainless steel
- » Includes three sets of aluminum bonding plates
- » Requires threaded adapter for top and bottom mounting (*purchased separately*)
- » **Applications:** Shear testing in Compression mode in accordance with ASTM C273/C273M and ASTM C394/C394M (Fatigue)



Specifications

Model	CMP.011
Part Number	100-056-205
Fixture Type	Flatwise Plane Shear Compression Fixture
Force Capacity	89 kN (20 kip)
Fixture Weight	14.5 kg (32 lbs)
Temperature Rating	-152° C (-240° F) to 318° C (600° F)
Mounting Thread	1"-14
Insert Sizes	
Fixture Height	368 mm (14.5 in)
Fixture Width	76 mm (3.0 in)

Integrated Specimen Interface

Maximum Length	228.6 mm (9 in)
Specimen Range	6.3-19.1 mm (0.25-0.75 in)
Maximum Width	76 mm (3.0 in)

*Temperature Range of Aluminum Bonding Plates -85 to 122°C (-120 to 250°F).

Climbing Drum Peel Fixture with Roller Type Grips

- » Climbing drum peel test fixture is constructed from high-quality stainless steel
- » Requires threaded adapter for top and bottom mounting (*purchased separately*)
- » **Applications:** Peel testing in accordance with ASTM D1781 (please contact MTS for fixture in accordance to with ASTM D1781M)



Specifications

Model	CMP.012
Part Number	100-363-421
Fixture Type	Climbing Drum Peel Fixture
Force Capacity	2.2 kN (0.5 kip)
Fixture Weight	13.6 kg (30 lbs)
Temperature Rating	-85° C (-120° F) to 122° C (250° F)
Mounting Thread	1"-14
Insert Sizes	
Fixture Height	671 mm (26.4 in)
Fixture Width	183 mm (7.2 in)

Integrated Specimen Interface

Length	254 mm (10 in)
Specimen Range	0.762-25.4 mm (0.03-1 in)
Width	25.4-102 mm (1-4 in)

Composites

3 & 4 Point Sandwich Beam Flexure / Shear Fixture

- » 3 & 4 point sandwich beam test fixture is constructed from high strength steel with a durable black oxide finish (except for rollers and pads)
- » Adjustable loading and support spans
- » Loading and support bars are supplied with loading pins and flat steel loading blocks held in alignment with springs (rubber pads not included)
- » Requires threaded adapter for top and bottom mounting (*purchased separately*)
- » **Applications:** Flexure (bend) testing in accordance with ASTM C393/C393M, ASTM D5467/D5467M, ASTM D7249/D7249M and ASTM D7250/D7250M

Specifications

Model	CMP.013
Part Number	100-351-826
Fixture Type	Short-Beam Strength Fixture
Force Capacity	11 kN (2.5 kip)
Fixture Weight	52 kg (114 lbs)
Temperature Rating	-85° C (-120° F) to 122° C (250° F)
Mounting Thread Insert Sizes	1"-14
Fixture Height	389 mm (15.3 in)
Fixture Width	635 mm (25 in)
Loading Nose Radius	51-305 mm (2-12 in)
Supporting Nose Radius	152-610 mm (6-24 in)
Integrated Specimen Interface	
Maximum Length	610 mm (24 in)
Maximum Width	100 mm (4 in)



CMP.013

Force Transducers / Load Cells

S-Beam Load Cells for Criterion Systems

- » S-Beam load cells for Criterion systems are designed for accuracy and linearity
- » Measures axial loads using S-shaped design with a single embedded strain gage
- » Offers exceptional value and extreme simplicity for low-capacity testing with minimal side loads
- » **Applications:** Ideal for low-force tension and compression testing of plastics, elastomers (rubbers), and paper



Specifications

Model	Part Number	Type	Force Rating	Accuracy	Overload Protection	Mounting Thread
LSB.100	057-513-001	S-beam	1 N	class 0.5 from 1 to 100%	800% of capacity	M6 x 1
LSB.500	057-481-201	S-beam	5 N	class 0.5 from 1 to 100%	800% of capacity	M6 x 1
LSB.101	057-481-202	S-beam	10 N	class 0.5 from 1 to 100%	800% of capacity	M6 x 1
LSB.251	057-481-203	S-beam	25 N	class 0.5 from 1 to 100%	800% of capacity	M6 x 1
LSB.501	057-481-204	S-beam	50 N	class 0.5 from 1 to 100%	800% of capacity	M6 x 1
LSB.102	057-481-205	S-beam	100 N	class 0.5 from 1 to 100%	800% of capacity	M6 x 1
LSB.252	057-481-206	S-beam	250 N	class 0.5 from 1 to 100%	800% of capacity	M6 x 1
LSB.502	057-481-301	S-beam	500 N	class 0.5 from 1 to 100%	420% of capacity	M6 x 1
LSB.103	057-481-302	S-beam	1000 N	class 0.5 from 1 to 100%	420% of capacity	M6 x 1
LSB.203	057-481-303	S-beam	2000 N	class 0.5 from 1 to 100%	420% of capacity	M6 x 1
LSB.503	057-496-001	S-beam	5000 N	class 0.5 from 1 to 100%	420% of capacity	M12 x 1.25

Low Profile Bending Beam Load Cells for Criterion Systems

- » Bending beam load cells for Criterion systems are designed for high accuracy, stiffness, overturning moment, stability, and linearity
- » Measure moderate axial loads using a compact design with four embedded strain gages
- » Low profile maximizes available test space
- » **Applications:** Ideal for low-force tension and compression testing of soft metals, plastics and reinforced plastics



Specifications

Model	Part Number	Type	Force Rating	Accuracy	Overload Protection	Mounting Thread
LPB.102	057-481-401	Low profile bending	100 N	class 0.5 from 1 to 100%	150% of capacity	M6 x 1
LPB.252	057-481-402	Low profile bending	250 N	class 0.5 from 1 to 100%	150% of capacity	M6 x 1
LPB.502	057-481-403	Low profile bending	500 N	class 0.5 from 1 to 100%	150% of capacity	M6 x 1

Force Transducers / Load Cells

Low Profile Shear Beam Load Cells for Criterion Systems

- » Shear beam load cells for Criterion systems are designed for high accuracy, stiffness, overturning moment, stability, and linearity
- » Measure moderately high axial loads using a unique design of four embedded strain gages
- » Low profile maximizes available test space
- » **Applications:** Ideal for low-force tension and compression testing of brittle metals and composites



Specifications

Model	Part Number	Type	Force Rating	Accuracy	Overload Protection	Mounting Thread
LPS.103	057-481-501	Low profile shear beam	1 kN	class 0.5 from 1 to 100%	150% of capacity	M12 x 1.25
LPS.253	057-481-502	Low profile shear beam	2.5 kN	class 0.5 from 1 to 100%	150% of capacity	M12 x 1.25
LPS.503	057-481-503	Low profile shear beam	5 kN	class 0.5 from 1 to 100%	150% of capacity	M12 x 1.25
LPS.104	057-481-504	Low profile shear beam	10 kN	class 0.5 from 1 to 100%	150% of capacity	M12 x 1.25
LPS.204	057-481-506	Low profile shear beam	20 kN	class 0.5 from 1 to 100%	150% of capacity	M12 x 1.25
LPS.304	057-481-505	Low profile shear beam	30 kN	class 0.5 from 1 to 100%	150% of capacity	M12 x 1.25
LPS.504	057-481-701	Low profile shear beam	50 kN	class 0.5 from 1 to 100%	150% of capacity	M27 x 2
LPS.105	057-481-702	Low profile shear beam	100 kN	class 0.5 from 1 to 100%	150% of capacity	M27 x 2
LPS.155	057-481-703	Low profile shear beam	150 kN	class 0.5 from 1 to 100%	150% of capacity	M27 x 2
LPS.205	057-481-901	Low profile shear beam	200 kN	class 0.5 from 1 to 100%	150% of capacity	M36 x 2
LPS.305	057-481-801	Low profile shear beam	300 kN	class 0.5 from 1 to 100%	150% of capacity	M36 x 2
LPS.505	058-497-801	Low profile shear beam	500 kN	class 0.5 from 1 to 100%	150% of capacity	M72 x 2
LPS.605	058-497-802	Low profile shear beam	600 kN	class 0.5 from 1 to 100%	150% of capacity	M72 x 2

Force Transducers / Load Cells

S-Beam Load Cells for Exceed Systems

- » S-beam load cells for Exceed systems are designed for accuracy and linearity
- » Measures axial loads using S-shaped design with a single embedded strain gage
- » Offers exceptional value and extreme simplicity for low-capacity testing with minimal side loads
- » **Applications:** Ideal for low-force tension and compression testing of plastics, elastomers (rubbers), and paper



Specifications

Model	Part Number	Load Cell Type	Mounting Threads	Capacity
LPS-0.6KGY	100-475-294	S-beam	M6X1.0	5 N
LPS-1KGY	100-475-293	S-beam	M6X1.0	10 N
LPS-2KGY	100-475-292	S-beam	M6X1.0	20 N
BAB-XS-5MY	100-475-291	S-beam	M8X1.25	50 N
BAB-XS-10MY	100-475-290	S-beam	M8X1.25	100 N
BSA-XS-25KGY	100-475-289	S-beam	M6X1.0	250 N
BSA-XS-50KGY	100-475-227	S-beam	M6X1.0	500 N
BSS-XS-100KGY	100-475-288	S-beam	M10X1.5	1 kN
BSS-200KGY	100-475-287	S-beam	M12X1.75	2 kN
BSS-XS-500KGY	100-475-286	S-beam	M12X1.75	5 kN
BSS-XS-1TY	100-474-950	S-beam	M12X1.75	10 kN

Low Profile Shear Beam Load Cells for Exceed Systems

- » Shear beam load cells for Exceed systems are designed for accuracy, stiffness, stability, and linearity
- » Measure moderately high axial loads
- » Low profile maximizes available test space
- » **Applications:** Ideal for low-force tension and compression testing of brittle metals and composites



Specifications

Model	Part Number	Load Cell Type	Mounting Threads	Capacity
DBSL-2TY	100-474-953	Low profile shear beam	M16X1.5	20 kN
DBSL-3TY	100-474-954	Low profile shear beam	M16X1.5	30 kN
DBSL-5TY	100-474-955	Low profile shear beam	M16X1.5	50 kN
DBSL-XS-5TY	100-474-956	Low profile shear beam	M24X1.5	50 kN
DBSL-XS-10TY	100-474-957	Low profile shear beam	M24X1.5	100 kN
LPS.205Y	100-467-455	Low profile shear beam	M36X3	200 kN
LPS.305Y	100-466-085	Low profile shear beam	M36X3	300 kN
LPS.605Y	058-503-302	Low profile shear beam	M72X3	600 kN

Tension Extensometers

Contacting Extensometers

AHX850 High Elongation Extensometers

- » AHX850 high elongation extensometer is compatible with MTS Criterion Universal Test Systems
- » High-resolution optical digital encoder eliminates noise, signal drift, and output changes
- » Balanced design with optimized arm and head weights
- » Swings away from test area when not in use
- » Meets or exceeds requirements for calibration according to ASTM E83 Class B1 and ISO 9513 Class 0.5 standards
- » The gripping force is applied using adjustable springs
- » **Applications:** Ideal for accurately measuring strain in specimens prone to large displacement while in tension such as polymers and other elastomers

Specifications

Model	AHX850
Part Number	100-512-885
Frame Family	Criterion
Measuring Range	10 - 850 mm (0.4 - 33.4 in)
Standard Gage Length	10 mm (0.4 in) 20 mm (0.8 in) 25 mm (1.0 in) 50 mm (2.0 in) 75 mm (2.95 in) 100 mm (3.9 in)
Maximum Specimen Dimensions	Width: 20 mm (0.8 in) Thickness: 30 mm (1.2 in)
Relative Error	1%
Resolution	0.006 mm (0.0002 in)
Temperature Range	5° C (41° F) to 50° C (122° F)
Height	1025 mm (40.4 in)
Width	90 mm (3.54 in)
Depth	310 mm (12.2 in)



AHX850



Tension Extensometers

Contacting Extensometers

LTX850 Long Travel Extensometers

- » High elongation extensometer compatible with MTS Exceed Universal Test Systems
- » Durable high strength aluminum structure
- » Dual independent digital input channels for upper and lower arms ensure accurate and reliable measurement
- » Changeable knife edges, adjustable gripping forces, and balance head and arm weight allow smooth following of material strain change with minimal stickiness
- » Meets or exceeds requirements for calibration according to ASTM E83 Class B1 and ISO 9513 Class 0.5 standards
- » The gripping force is applied using adjustable springs
- » **Applications:** Ideal for accurately measuring strain in specimens prone to large displacement while in tension such as polymers and other elastomer

Specifications

Model	LTX850
Part Number	100-542-797
Frame Family	Exceed
Measuring Range	10 - 850 mm (0.4 - 33.4 in)
Standard Gage Length	10 mm (0.4 in) 20 mm (0.8 in) 25 mm (1.0 in) 50 mm (2.0 in) 75 mm (2.95 in)
Maximum Specimen Dimensions	Width: 20 mm (0.8 in) Thickness: 30 mm (1.2 in)
Relative Error	1%
Resolution	0.006 mm (0.0002 in)
Temperature Range	5° C (41° F) to 50° C (122° F)
Height	1030 mm (40.6 in)
Width	90 mm (3.54 in)
Depth	255 mm (10 in)



LTX850



Tension Extensometers

Contacting Extensometers

FAX1352 Automatic Extensometers

- » FAX1352 automatic extensometer is compatible with MTS Criterion and Exceed Universal Test Systems
- » Designed for longevity
- » Optimized for high-volume testing of single gage length specimens
- » Rotational Mount allows the operator to quickly rotate the FAX out of the test area for easy access to the specimen
- » **Applications:** Ideal for axial strain measurement for tensile testing on Universal Test Systems

Specifications

Model	FAX1352
Part Number	100-530-550
Frame Family	Criterion & Exceed
Measuring Range	0 - 80 mm (0 - 3.1 in)
Gage Length*	12.5 – 200 mm (0.5 – 7.9 in)
Thickness or Diameter Range	Flats: 0.2 - 40 mm (0.0008 – 1.57 in) Rounds: 0.2 - 40 mm (0.0008 – 1.57 in)
Relative Error	±1%
Axial Resolution	≤0.2 μm
Temperature Range	5° C (41° F) to 40° C (104° F)
Height	530 mm (20.9 in)
Width	120 mm (4.7 in)
Depth	673 mm (26.5 in)
Input Power	100-240 VAC 50/60Hz 1.4A

* Recalibration is required whenever the specimen gage length is changed.



FAX1352



Rotational Mount

Tension Extensometers

Contacting Extensometers

Series 635 Monotonic Tensile Extensometers

- » Series 635 extensometers are specially designed for popular monotonic axial tensile strain measurement. They are an economic choice, ideal for large volume QA/QC testing.
- » Features proprietary strain gaged elements made from special heat-treated alloy
- » Ground profile, dual-member flexure provides for very low activation force with excellent strength
- » True center-point bending resulting in low hysteresis and exceptionally accurate strain readings
- » Mechanical stops can be attached through specimen failure without damaging the unit
- » Zero-set pin enables accurate and consistent determination of the initial gage length
- » Not intended for immersion in water or other liquids
- » Hardened, replaceable knife edges for flat and round specimens are included
- » Patented MTS quick-attach springs for fast and easy specimen attachment are included
- » Standard 1.5 m (60 in) cable is included
- » Typical Linearity¹ is 0.08% of range
- » Accuracy² designed to meet ASTM E83 Class B1 and ISO 9513 Class 0.5 standards
- » Temperature Range is 4° C to 50° C (40° F to 120° F)
- » **Applications:** Axial tensile strain measurements for large volume QA/QC testing



Specifications

Model	Part Number	Gage Length	Maximum Travel	Maximum Strain	Length (from knife edge to back of housing)	Height (from bottom to top)
635.25F-05	057-863-506	25 mm	+ 5 mm	20%	77.5 mm (3.1 in)	39.6 mm (1.1 in)
635.50F-05	057-863-505	50 mm	+ 5 mm	10%	77.5 mm (3.1 in)	59.2 mm (2.3 in)
635.50F-10	057-863-504	50 mm	+ 10 mm	20%	77.5 mm (3.1 in)	61.5 mm (2.4 in)
635.50F-25	057-863-503	50 mm	+ 25 mm	50%	153.7 mm (6.1 in)	69.1 mm (2.7 in)
635.100F-10	057-863-502	100 mm	+ 10 mm	10%	77.5 mm (3.1 in)	111.8 mm (4.4 in)
635.100F-25	057-863-501	100 mm	+ 25 mm	25%	153.7 mm (6.1 in)	119.1 mm (4.7 in)

Notes:

¹ Linearity stated is for ascending data and is the deviation from best fit straight line thru zero expressed as a percent of full scale.

² Calibrations are separate. These extensometers leave the factory with a quality validation and verification by sampling three measurement points to validate performance. The 635 series extensometers are intended to meet ASTM class B-1 and ISO class 0,5.

Environmental Simulation

Chambers

MTS Advantage Environmental Chambers

- » MTS Advantage environmental chambers increase range of temperatures available for materials testing
- » Enables testing at a constant temperature with very little gradient across the specimen
- » Compatible with video or laser extensometers
- » Optional heated window available
- » **Applications:** Materials testing at controlled temperatures for research, quality control and production testing of elastomeric components, tire cords, plastics, composites, laminates, etc.



AEC 10x10x32

Specifications

Model	AEC 10x10x24	AEC 10x10x32	AEC 14x17x24	AEC 14x17x32
Part Number	Configurable	Configurable	Configurable	Configurable
Temperature Rating	-129° C (-200° F) to 316° C (600° F)	-129° C (-200° F) to 316° C (600° F)	-129° C (-200° F) to 316° C (600° F)	-129° C (-200° F) to 316° C (600° F)
Internal Width	254 mm (10 in)	254 mm (10 in)	356 mm (14 in)	356 mm (14 in)
Internal Depth	254 mm (10 in)	254 mm (10 in)	432 mm (17 in)	432 mm (17 in)
Internal Height	610 mm (24 in)	813 mm (32 in)	610 mm (24 in)	813 mm (32 in)
External Width	406 mm (16 in)	406 mm (16 in)	508 mm (20 in)	508 mm (20 in)
External Depth	737 mm (29 in)	737 mm (29 in)	914 mm (36 in)	914 mm (36 in)
External Height	762 mm (30 in)	965 mm (38 in)	762 mm (30 in)	965 mm (38 in)

Environmental Simulation

Furnaces

Model 653 Furnaces

- » MTS Model 653 furnaces incorporate the MTS Model 409.83 temperature controller to provide high-temperature testing environments
- » Capable of achieving temperatures up to 1000° C (1832° F) in validated testing conditions
- » Single or multiple zone heating
- » Clamshell design streamlines test setup, furnace alignment, and specimen changeover
- » Silicon carbide heating elements and alumina fiber insulation system for low heat loss and long life
- » Multiple furnace heights to accommodate diverse test requirements
- » Mounting bracket for a variety of MTS load frames is included
- » Designed to accommodate MTS high-temperature axial extensometers
- » Multiple mounting options – on included furnace mounting bracket or optional stand for floor or table
- » Compact, ergonomic design
- » Multiple level, self-tuning PID control
- » SCR power relays included
- » Digital communications available
- » **Applications:** Ideal for high-temperatures tension and compression testing of metals, composites, ceramics, and a wide variety of materials



* Supports testing to ASTM E606-04e1, BSI 7270, JIS Z2279, AFNOR A03-403, ISO 12106, ISO (EN) 6892-2, ASTM E21, prEN 2002-2 or GB/T 228.2 requirements.

Note: When ordering, please indicate voltage requirements and provide necessary load frame dimensions in order to determine system integration requirements.

Specifications

Model	653.01	653.02	653.03	653.04**
Part Number	Configurable	Configurable	Configurable	Configurable
Temperature Rating*	200° C (392° F) to 1000° C (1832° F)	200° C (392° F) to 1000° C (1832° F)	200° C (392° F) to 1000° C (1832° F)	200° C (392° F) to 1000° C (1832° F)
Overall Height	55 mm (2.2 in)	85 mm (3.3 in)	126 mm (5 in)	220 mm (6.7 in)
Hot Zone Height	19 mm (0.75 in)	50 mm (1.97 in)	90 mm (3.54 in)	185 mm (7.28 in)
Hot Zone Width & Depth	50 x 50 mm (1.97 x 1.97 in)	50 x 50 mm (1.97 x 1.97 in)	62.5 x 62.5 mm (2.46 x 2.46 in)	62.5 x 62.5 mm (2.46 x 2.46 in)
Number of Zones	1	2	2	3

Environmental Simulation

Extension Rods – Chambers

MTS EM Extend Kits

- » MTS EM Extend Kits include a variety of extension rods to enhance testing flexibility and reduce test setup time.
- » All extension rods have ports for water cooling
- » Stainless steel construction minimizes heat transfer
- » Lightweight design minimizes tare weight
- » Tight tolerances ensure angular and concentric alignment are retained
- » Highly configurable to test various size specimens. Compression platens are usually low profile and will need more extension lengths. Pneumatic grips take up more space and will require fewer lengths
- » Type C, D & E kits consists of five different extension lengths that can be configured into 23 different length combinations
- » Upper extension rod can be adjusted in increments providing multiple pin-to-pin dimensions
- » Preloaded joints
- » **Applications:** Apply tension and compression in an environmental chamber to test low and high profile accessories or short and tall specimens



Type "C"



Type "D"

Load extension kits are packaged in a protective case. From left to right, the lengths are denoted as L1 through L5.

Specifications

Model	EME202	EME155	EME305
Part Number	100-151-425	100-150-815	100-310-560
Type	Stainless Steel Water Cooled Extension Rod Kit	Stainless Steel Water Cooled Extension Rod Kit	Stainless Steel Water Cooled Extension Rod Kit
Force Capacity	0.2 kN (45 lbs)	150 kN (33,700 lbs)	300 kN (67,440 lbs)
Temperature Rating	-130° C (-200° F) to 315° C (600° F)	-130° C (-200° F) to 315° C (600° F)	-130° C (-200° F) to 315° C (600° F)
Attachment Type	C	D	E

Note: Optional Water Cooling Kit - 57697506.

Environmental Simulation

Extension Rods – Furnaces

MTS Fundamental Extension Rods

- » Affordable extension rods designed for high-temperature environments
- » All extension rods have water cooling ports
- » Special alloy enables high-temperature testing
- » Specimen interface can be changed while using the extension rod to reduce test setup time
- » **Applications:** Ideal for high-temperature tension and compression testing



Specifications

Model	FHA000	FHA001
Part Number	100-231-867	100-277-341
Type	High Temperature Alloy Water Cooled Extension Rod	High Temperature Alloy Water Cooled Extension Rod
Force Capacity	80 kN (18,000 lbf)*	80 kN (18,000 lbf)*
Temperature Rating	0° C (0° F) to 1050° C (0 - 1922° F)	0° C (0° F) to 1050° C (0 - 1922° F)
Attachment Type	D	E
Extension Rod Length	364 mm (14.3 in)	399 mm (15.7 in)
Upper Extension Rod Weight	2.9 kg (6.5 lbs)	5 kg (11 lbs)

* Force capacity at room temp, consult MTS Application Engineer for maximum force capacities at elevated temperatures.

Optional Specimen Interface Furnace Extension Rods

Model	Part Number	Profile	Height	Upper Extension Rod Weight	Temperature Range	Specimen Range
FHA110	100-231-868	Threaded	80 mm (3.1 in)	0.46 kg (1 lbs)	0° C (0° F) to 1050° C (0 - 1922° F)	M16 x 2
FHA120	100-231-869	Threaded	98 mm (3.8 in)	0.58 kg (1.3 lbs)	0° C (0° F) to 1050° C (0 - 1922° F)	M12 x 1.75
FHA210	100-231-870	Flat	68 mm (2.7 in)	0.39 kg (0.9 lbs)	0° C (0° F) to 1050° C (0 - 1922° F)	1-4 mm (0.04-0.16 in)
FHA220	100-231-871	Flat	83 mm (3.3 in)	0.74 kg (1.6 lbs)	0° C (0° F) to 1050° C (0 - 1922° F)	4-8 mm (0.16-0.31 in)

Spares Kits

Same Kit for Extension Length Version

Specifications

Model	Part Number	Description
C41.103Y	100-529-712	This kit includes certain switches, bellows, all belts, clevis pins and tools.
C42.503Y	100-530-555	This kit includes certain switches, bellows, all belts, clevis pins and tools.
C43.104Y	100-530-558	This kit includes certain switches, bellows, all belts, clevis pins and tools.
C43.304Y	100-530-559	This kit includes certain switches, bellows, all belts, clevis pins and tools.
C43.504Y	100-530-560	This kit includes certain switches, bellows, all belts, clevis pins and tools.
C44.304Y	100-530-562	This kit includes certain switches, bellows, all belts, clevis pins and tools.
C45.504Y	100-530-563	This kit includes certain switches, bellows, all belts, clevis pins and tools.
C45.504WY	100-530-564	This kit includes certain switches, bellows, all belts, clevis pins and tools.
C45.105Y	100-530-565	This kit includes certain switches, bellows, all belts, clevis pins and tools.
C45.305Y	100-530-566	This kit includes certain switches, bellows, all belts, clevis pins and tools.
C45.605Y	100-530-567	This kit includes certain switches, bellows, all belts, clevis pins and tools.

Note: Y on model number indicates Criterion load frame with ICE controller.

Specifications

Model	Part Number	Description
E42.503	100-303-303	This kit includes certain switches, bellows, all belts, clevis pins and tools.
E43.104	100-303-304	This kit includes certain switches, bellows, all belts, clevis pins and tools.
E43.504	100-367-234	This kit includes certain switches, bellows, all belts, clevis pins and tools.
E44.304	100-303-305	This kit includes certain switches, bellows, all belts, clevis pins and tools.
E45.105	100-303-306	This kit includes certain switches, bellows, all belts, clevis pins and tools.
E45.305	100-303-307	This kit includes certain switches, bellows, all belts, clevis pins and tools.
E45.605	100-303-308	This kit includes certain switches, bellows, all belts, clevis pins and tools.

Grips & Fixtures Index

Model	Part Number	Description	Page
645.002	100-242-422	2 kN Pneumatic Wedge	11
645.005	100-242-417	5 kN Pneumatic Wedge	11
653.01	Configurable	653 Furnaces	76
653.02	Configurable	653 Furnaces	76
653.03	Configurable	653 Furnaces	76
653.05	Configurable	653 Furnaces	76
635.100F-10	057-863-502	635.100F Monotonic Tensile Extensometers	74
635.100F-25	057-863-501	635.100F Monotonic Tensile Extensometers	74
635.25F-05	057-863-506	635.25F Monotonic Tensile Extensometers	74
635.50F-05	057-863-505	635.50F Monotonic Tensile Extensometers	74
635.50F-10	057-863-504	635.50F Monotonic Tensile Extensometers	74
635.50F-25	057-863-503	635.50F Monotonic Tensile Extensometers	74
642.001-SST	100-201-458	1 kN Stainless Steel 3 & 4 Point	47
642.001A-02	100-033-663	1 kN 3 & 4 Point Bend	47
642.01-SST	100-203-454	12 kN Stainless Steel 3 & 4 Point Bend	48
642.01A-02	100-024-684	12 kN 3 & 4 Point Bend	48
642.10B-02	100-024-686	125 kN 3 & 4 Point Bend	48
642.25B-02	100-024-688	300 kN 3 & 4 Point Bend	48
643.06A-01/-02	100-024-676	689 MPa Fixed/Spherical Steel Platen	44
643.06A-03/-04	100-024-675	689 MPa Fixed/Fixed Steel Platen	44
643.10A-01/-02	100-024-678	689 MPa Fixed/Spherical Steel Platen	44
643.10A-03/-04	100-024-677	689 MPa Fixed/Fixed Steel Platen	44
643.15A-01/-02	100-024-680	689 MPa Fixed/Spherical Steel Platen	44
643.15A-03/-04	100-024-679	689 MPa Fixed/Fixed Steel Platen	44
643.20A-01/-02	100-215-231	689 MPa Fixed/Spherical Steel Platen	44
643.20A-03/-04	100-215-230	689 MPa Fixed/Fixed Steel Platen	44
643.30A-01/-02	100-024-682	689 MPa Fixed/Spherical Steel Platen	44
643.30A-03/-04	100-024-681	689 MPa Fixed/Fixed Steel Platen	44
647.02B	056-670-901	30 kN Hydraulic Wedge	8
647.10A	047-080-605	100 kN Hydraulic Wedge	8
647.25A	047-080-905	300 kN Hydraulic Wedge	8
647.50A	047-595-505	550 kN Hydraulic Wedge	8
685.10E-05	057-509-601	Hydraulic Grip Controller/Supply	42
685.10E-06	057-509-602	Hydraulic Grip Controller/Supply	42
685.10E-07	057-509-603	Hydraulic Grip Controller/Supply	42
685.10E-08	057-509-604	Hydraulic Grip Controller/Supply	42
685.22D-05	057-598-001	Hydraulic Grip Controller/Supply	42
685.22D-06	057-598-002	Hydraulic Grip Controller/Supply	42
685.22D-07	057-598-003	Hydraulic Grip Controller/Supply	42
685.22D-08	057-598-004	Hydraulic Grip Controller/Supply	42
AEC 10x10x24	Configurable	Advantage Environmental Chambers	75

Model	Part Number	Description	Page
AEC 10x10x32	Configurable	Advantage Environmental Chambers	75
AEC 14x17x24	Configurable	Advantage Environmental Chambers	75
AEC 14x17x32	Configurable	Advantage Environmental Chambers	75
AHX850	100-512-885	High Elongation Extensometers - Criterion	71
APC1850	100-393-631	Advantage Single Action Pneumatic	43
APG101	100-032-017	0.01 kN Pneumatic Vise	13
APG104	100-034-623	10 kN Pneumatic Vise	13
APG202	100-036-576	0.2 kN Pneumatic Vise	13
APG203	100-280-342	2 kN Pneumatic Vise	13
ASG102	055-426-701	0.01 kN Manual Screw	20
ASG104	100-030-185	10 kN Manual Screw	20
ASG203	055-426-801	0.2 kN Manual Screw	20
ASG503	055-426-901	2 kN Manual Screw	20
AWG104	056-079-501	10 kN Manual Wedge	26
AWG105	056-079-801	100 kN Manual Wedge	26
AWG304	052-862-001	30 kN Manual Wedge	26
AWG305	100-270-777	300 kN Manual Wedge	26
AWG504	054-951-001	50 kN Manual Wedge	26
BAB-XS-10MY	100-475-290	100 N S-Beam Load Cells - Exceed	70
BAB-XS-5MY	100-475-291	50 N S-Beam Load Cells - Exceed	70
BCP104A	100-182-229	10 kN Fixed/Fixed Stainless Steel Platen	58
BCP104B	100-182-227	10 kN Fixed/Fixed Stainless Steel Platen	58
BCP104C	100-203-455	10 kN Fixed/Fixed Stainless Steel Platen	58
Bionix EnviroBath 1	Configurable	2.4 kN Fluid Baths	59
Bionix EnviroBath 10	Configurable	10 kN Fluid Baths	59
Bionix EnviroBath 6	Configurable	2.4 kN Fluid Baths	59
BMB103	100-185-264	1 kN Manual Bollard	54
BMR103	100-185-262	1 kN Roller	55
BMR203	100-184-839	2 kN Roller	55
BMR503	100-184-841	5 kN Roller	55
BMS103	100-181-625	1 kN Manual Scissor	54
BMS10A	056-644-001	0.003 kN Stainless Steel Spring	56
BMS10B	056-644-002	0.01 kN Stainless Steel Spring	56
BMV102	100-186-411	0.1 kN Manual Vise	57
BMV203	100-174-783	2 kN Manual Vise	57
BMV503	100-186-413	5 kN Manual Vise	57
BSA-XS-25KGY	100-475-289	200 N S-Beam Load Cells - Exceed	70
BSA-XS-50KGY	100-475-227	500 N S-Beam Load Cells - Exceed	70
BSS-200KGY	100-475-287	2 kN S-Beam Load Cells - Exceed	70
BSS-XS-100KGY	100-475-288	1 kN S-Beam Load Cells - Exceed	70
BSS-XS-1TY	100-474-950	10 kN S-Beam Load Cells - Exceed	70

Grips & Fixtures Index

Model	Part Number	Description	Page
BSS-XS-500KGY	100-475-286	5 kN S-Beam Load Cells - Exceed	70
BTV102	100-167-987	0.1 kN Stainless Steel Manual Vise	24
C41.103Y	100-529-712	Spares Kits	79
C42.503Y	100-530-555	Spares Kits	79
C43.104Y	100-530-558	Spares Kits	79
C43.304Y	100-530-559	Spares Kits	79
C43.504Y	100-530-560	Spares Kits	79
C44.304Y	100-530-562	Spares Kits	79
C45.105Y	100-530-565	Spares Kits	79
C45.305Y	100-530-566	Spares Kits	79
C45.504WY	100-530-564	Spares Kits	79
C45.504Y	100-530-563	Spares Kits	79
C45.605Y	100-530-567	Spares Kits	79
CB504E	100-302-702	50 kN Manual Roller	18
CMP.001	100-351-817	88 kN Modified Celanese Compression	61
CMP.002	100-351-818	267 kN IITRI Compression Loading	61
CMP.003	100-351-819	89 kN Combined Loading Compression	62
CMP.004	100-351-820	44 kN V-Notched Rail Shear Fixture	62
CMP.005	100-087-239	44 kN V-Notched Beam Shear Fixture	63
CMP.006	100-351-821	8.9 kN Short-Beam Strength Fixture	63
CMP.007	100-351-822	4.4 kN Mixed Mode Bending Fixture	64
CMP.008	100-351-823	222 kN Open Hole Compression Fixture	64
CMP.009	100-351-824	222 kN Compression After Impact Fixture	65
CMP.010	100-204-294	89 kN Flatwise Plane Shear Tensile Fixture	65
CMP.011	100-056-205	89 kN Flatwise Plane Shear Compression	66
CMP.012	100-363-421	2.2 kN Climbing Drum Peel Fixture	66
CMP.013	100-351-826	11 kN Short-Beam Strength Fixture	67
DBSL-2TY	100-474-953	20 kN Low Profile Shear Beam - Exceed	70
DBSL-3TY	100-474-954	30 kN Low Profile Shear Beam - Exceed	70
DBSL-5TY	100-474-955	50 kN Low Profile Shear Beam - Exceed	70
DBSL-XS-10TY	100-474-957	100 kN Low Profile Shear Beam - Exceed	70
DBSL-XS-5TY	100-474-956	50 kN Low Profile Shear Beam - Exceed	70
DL07589.01	100-302-770	200 kN Fixed/Fixed Steel Platen	46
DSA103B	100-302-669	1 kN Manual Screw	21
DSA104B	100-302-671	10 kN Manual Screw	21
DSA204B	100-302-673	20 kN Manual Vise	24
DX104A	100-302-665	10 kN Manual Vise	25
DX105A	100-302-666	100 kN Manual Vise	25
E42.503	100-303-303	Spares Kits	79
E43.104	100-303-304	Spares Kits	79
E43.504	100-367-234	Spares Kits	79

Model	Part Number	Description	Page
E44.304	100-303-305	Spares Kits	79
E45.105	100-303-306	Spares Kits	79
E45.305	100-303-307	Spares Kits	79
E45.605	100-303-308	Spares Kits	79
EME155	100-150-815	150 kN SST Water Cooled Rod Kit	77
EME202	100-151-425	0.2 kN SST Water Cooled Rod Kit	77
EME305	100-310-560	300 kN SST Water Cooled Rod Kit	77
FAX1352	100-530-550	Automatic Extensometers - Criterion & Exceed	73
FCA104B	100-258-157	10 kN Manual Bollard	16
FCA105C	100-257-526	100 kN Manual Roller	18
FCB502B	100-231-828	0.5 kN Manual Bollard	15
FCF103	100-087-526	1 kN Coefficient of Friction	53
FCH203A	100-231-829	2 kN Manual Bollard	15
FCQA502A	100-231-830	0.5 kN Pneumatic Bollard	12
FDQA103B	100-231-831	1 kN Pneumatic Vise	14
FDQA503B	100-279-862	5 kN Pneumatic Vise	14
FDSA102A	100-231-832	0.1 kN Manual Vise	23
FDSA502B	100-231-833	0.5 kN Manual Vise	23
FDSC503B	100-238-152	1 kN Manual Screw	21
FSD503A	100-231-400	5 kN Manual Vise	23
FDYA504A	100-408-988	50 kN Hydraulic Single Side	9
FDYB105A	100-302-638	100 kN Hydraulic Single Side	9
FGD203A	100-231-401	2 kN Manual Scissor	19
FGD503A	100-231-402	5 kN Manual Scissor	19
FHA000	100-231-867	80 kN Water Cooled Extension Rod	78
FHA001	100-277-341	80 kN Water Cooled Extension Rod	78
FLA105B	100-258-716	100 kN Nut & Bolt	17
FLA305A	100-637-668	300 kN Nut & Bolt	17
FLA605B	100-532-788	600 kN Nut & Bolt	17
FMB205	100-409-047	200 kN Manual Bollard	16
FMB503A	100-034-764	5 kN Manual Bollard	15
FMB503B	100-034-765	5 kN Manual Bollard	15
FMR503	100-033-790	5 kN Manual Roller	18
FMV101	100-033-784	0.01 kN Manual Vise	24
FMV102	100-033-242	0.1 kN Manual Vise	24
FPB503	100-139-065	5 kN Pneumatic Bollard	12
FPC2850	100-416-592	Fundamental Dual Action Pneumatic	43
PPF452	100-170-762	0.45 kN 90° Peel Fixture	52
FTA105B	100-258-715	100 kN Shoulder	22
FTA305B	100-296-160	300 kN Shoulder	22
FWA104A	100-231-417	10 kN 3 Point Bend Fixture	50

Grips & Fixtures Index

Model	Part Number	Description	Page
FWA105A	100-231-418	100 kN 3 Point Bend Fixture	50
FWA305A	100-258-158	300 kN 3 Point Bend Fixture	50
FWA605	100-504-190	600 kN 3 Point Bend Fixture	50
FWX105	100-258-159	100 kN Universal Joint Grip	7
FXSA104B	100-257-698	10 kN Manual Wedge	27
FXSA105A	100-231-405	100 kN Manual Wedge	27
FXSA304B	100-231-404	30 kN Manual Wedge	27
FXSA305A	100-257-525	300 kN Manual Wedge	27
FYA105A	100-231-406	100 kN Fixed/Fixed Steel Platen	45
FYA204A	100-231-407	20 kN Fixed/Fixed Steel Platen	45
FYA502A	100-231-408	0.5 kN Fixed/Fixed Aluminum Platen	46
FYB204A	100-231-411	20 kN Fixed/Fixed Steel Platen	45
FYB305A	100-257-355	300 kN Fixed/Fixed Steel Platen	45
FYB502A	100-231-412	0.5 kN Fixed/Fixed Aluminum Platen	46
FYC105A	100-231-413	100 kN Fixed/Fixed Steel Platen	45
FYC305A	100-257-356	300 kN Fixed/Fixed Steel Platen	45
FYD305	100-336-772	300 kN Hydraulic Wedge	10
FYD605	100-369-052	600 kN Hydraulic Wedge	10
LPB.102	057-481-401	100 N Low Profile Bending Beam - Criterion	68
LPB.252	057-481-402	250 N Low Profile Bending Beam - Criterion	68
LPB.502	057-481-403	500 N Low Profile Bending Beam - Criterion	68
LPS-0.6KGY	100-475-294	5 N S-Beam Load Cells - Criterion	70
LPS-1KGY	100-475-293	10 N S-Beam Load Cells - Criterion	70
LPS-2KGY	100-475-292	20 N S-Beam Load Cells - Criterion	70
LPS.103	057-481-501	1 kN Low Profile Shear Beam - Criterion	69
LPS.104	057-481-504	10 kN Low Profile Shear Beam - Criterion	69
LPS.105	057-481-702	100 kN Low Profile Shear Beam - Criterion	69
LPS.155	057-481-703	150 kN Low Profile Shear Beam - Criterion	69
LPS.204	057-481-506	20 kN Low Profile Shear Beam - Criterion	69
LPS.205	057-481-901	200 kN Low Profile Shear Beam - Criterion	69
LPS.205Y	100-467-455	200 kN Low Profile Shear Beam - Exceed	70
LPS.253	057-481-502	2.5 kN Low Profile Shear Beam - Criterion	69
LPS.304	057-481-505	30 kN Low Profile Shear Beam - Criterion	69
LPS.305	057-481-801	300 kN Low Profile Shear Beam - Criterion	69
LPS.305Y	100-466-085	300 kN Low Profile Shear Beam - Exceed	70
LPS.503	057-481-503	5 kN Low Profile Shear Beam - Criterion	69
LPS.504	057-481-701	50 kN Low Profile Shear Beam - Criterion	69
LPS.505	058-497-801	500 kN Low Profile Shear Beam - Criterion	69
LPS.605	058-497-802	600 kN Low Profile Shear Beam - Exceed	70
LPS.605Y	058-503-302	600 kN Low Profile Shear Beam - Criterion	69
LSB.100	057-513-001	1 N S-Beam Load Cells - Criterion	68

Model	Part Number	Description	Page
LSB.101	057-481-202	10 N S-Beam Load Cells - Criterion	68
LSB.102	057-481-205	100 N S-Beam Load Cells - Criterion	68
LSB.103	057-481-302	1000 N S-Beam Load Cells - Criterion	68
LSB.203	057-481-303	2000 N S-Beam Load Cells - Criterion	68
LSB.251	057-481-203	25 N S-Beam Load Cells - Criterion	68
LSB.252	057-481-206	250 N S-Beam Load Cells - Criterion	68
LSB.500	057-481-201	5 N S-Beam Load Cells - Criterion	68
LSB.501	057-481-204	50 N S-Beam Load Cells - Criterion	68
LSB.502	057-481-301	500 N S-Beam Load Cells - Criterion	68
LSB.503	057-496-001	5000 N S-Beam Load Cells - Criterion	68
LTX850	100-542-797	High Elongation Extensometers - Exceed	72
WA102A	100-302-793	0.5 kN 3 Point Bend Fixture	51
WA204A	100-660-347	20 kN 3 Point Bend Fixture	51
ZDPA503	100-302-835	5 kN Puncture Fixture	52
ZLD204	100-302-722	20 kN Manual Bollard	16
ZWC104A	100-302-802	10 kN 3 Point Bend Fixture	51

Notes

Regional Business Centers

THE AMERICAS

MTS Systems Corporate
14000 Technology Drive
Eden Prairie, MN 55344-2290
USA
Telephone: 952-937-4000
Toll Free: 800-328-2255
E-mail: info@mts.com
Internet: www.mts.com

EUROPE

MTS Systems France
BAT EXA 16
16/18 rue Eugène Dupuis
94046 Créteil Cedex
France
Telephone: +33-(0)1-58 43 90 00
E-mail: contact.france@mts.com

MTS Systems (Germany) GmbH
Hohentwielsteig 3
14163 Berlin
Germany
Telephone: +49-(0)30 81002-0
E-mail: euroinfo@mts.com

MTS Systems S.R.L. a socio unico
Strada Pianezza 289
10151 Torino
Italy
Telephone: +39-(0)11 45175 11 sel. pass.
E-mail: mtstorino@mts.com

MTS Systems Norden AB
Datavägen 37b
SE-436 32 Askim
Sweden
Telephone: +46-(0)31-68 69 99
E-mail: norden@mts.com

MTS Systems Limited
98 Church Street,
Hunslet,
Leeds
LS102AZ
United Kingdom
Telephone: +44 (0) 113 270 8011
E-mail: mtsuksales@mts.com

ASIA/PACIFIC

MTS Japan Ltd.
Raider Bldg. 3F 3-22-6,
Ryogoku, Sumida-ku,
Tokyo 130- 0026
Japan
Telephone: +81 3 5638 0850
E-mail: mts-j-info@mts.com

MTS Korea, Inc.
2nd F, Bundang Yemiji Building, 31,
Hwangsaeul-ro 258beon-gil,
Bundang-gu, Seongnam-si,
Gyeonggi-do, 13595
Korea
Telephone: +82-31-728-1600
E-mail: mtsk-info@mts.com

MTS Systems (China) Co., Ltd.
Floor 34, Building B,
New Caohejing International
Business Center,
No.391, Guiping Road,
Xuhui District
Shanghai 200233
P.R.China
Telephone: +021-24151000
Market: +021-24151111
Sales: +021-24151188
Service: +021-24151198
E-mail: MTSC-Info@mts.com

MTS Testing Solutions Pvt Ltd.
Unit No. 201 & 202, Second Floor
Donata Radiance,
Krishna Nagar Industrial Layout,
Koramangala, Bangalore - 560029
Karnataka, India
Telephone: + 91 80 46254100
Email: mts.india@mts.com



MTS Systems Corporation
14000 Technology Drive
Eden Prairie, MN 55344-2290 USA

ISO 9001 Certified QMS
<http://www.mts.com>

MTS, MTS Criterion, MTS Exceed and Bionix are registered trademarks and MTS Advantage, MTS Fundamental and MTS TestSuite are trademarks of MTS Systems Corporation in the United States. These trademarks may be protected in other countries. RTM No. 211177.

©2024 MTS Systems Corporation
100-672-724e Criterion&ExceedAccessories • Printed in U.S.A. • 03/24