

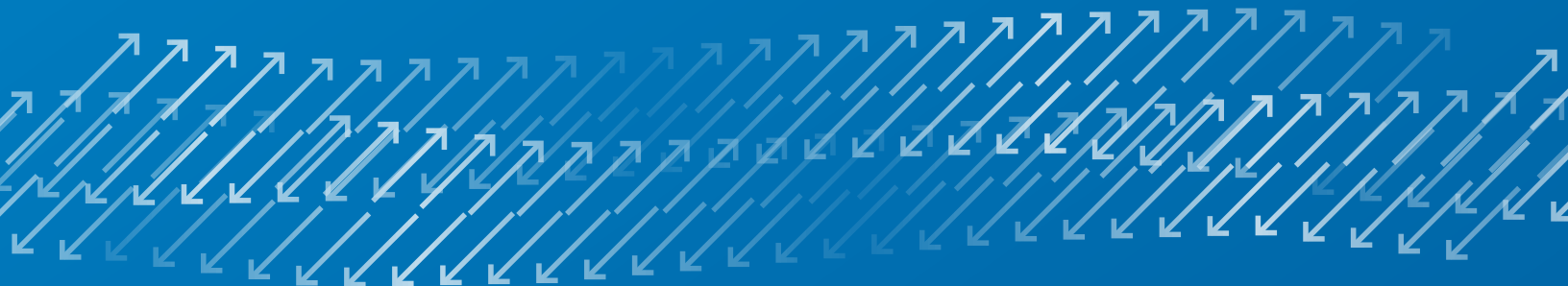

MTS Landmark® Testing Solutions

Versatile, high-performance servohydraulic systems for static and dynamic material and component testing

MTS LANDMARK SYSTEMS INTEGRATE THE LATEST IN MTS
SERVOHYDRAULIC INNOVATION, VERSATILE FLEXTTEST[®]
CONTROLS, PROVEN MTS APPLICATION SOFTWARE AND A
COMPLETE SELECTION OF ACCESSORIES TO PROVIDE HIGHLY
ACCURATE AND REPEATABLE STATIC AND DYNAMIC TESTING
ACROSS THE MATERIAL TESTING CONTINUUM.



MTS Landmark Servohydraulic Test Systems

Meet a full spectrum of static and dynamic material test requirements – now and well into the future

Available in highly configurable floor-standing and tabletop models, these systems are ideal for testing components and materials such as plastics, elastomers, aluminum, composites, steel, super alloys and more.

Marking the optimization of the world's most widely deployed servohydraulic testing technology, the MTS Landmark System delivers the high-performance and flexibility that MTS test systems are renowned for in a new highly stiff, ergonomic and easy-to-maintain load frame.

- » High cycle fatigue
- » Low cycle fatigue
- » Advanced low cycle fatigue
- » Fatigue crack growth
- » Fracture toughness
- » Crack propagation
- » K_{1c}, J_{1c}
- » Component strength and durability
- » Environmental testing
- » Thermal mechanical fatigue
- » Tension
- » Compression
- » Bending
- » Stress relaxation



Material Testing Continuum

Force Range		5 kN (1 kip)	25 kN (5.5 kip)	100 kN (22 kip)	250 kN (55 kip)	500 kN (110 kip)		
Range of Available Performance	TABLETOP	Moderate		High		Very High	FLOOR-STANDING	
Material Strength		Plastics	Elastomers	Aluminum	Composites	Steel		Super Alloys
Specimen Size		Subsized		Standard		Medium		Large



MTS

MTS

Flex
Test

MTS FlexTest 40
Digital Extensometer

A milestone in the long history of MTS material testing leadership and innovation, the MTS Landmark System is an amalgam of more than four decades of MTS servohydraulic testing expertise, in-depth customer research and a world-class industrial design program.

More than four decades of MTS Servohydraulic Expertise

MTS pioneered the servohydraulic load frame technology that remains a mainstay to this day across a broad range of industries. The MTS Landmark platform leverages this history of servohydraulic technology leadership and innovation to deliver the unmatched accuracy, repeatability and the flexibility you need to meet a full spectrum of static and dynamic material test requirements – now and well into the future.



Unparalleled MTS Support

MTS fields the largest, most experienced worldwide service, support and consulting staff of any testing solution provider. This global team offers complete lifecycle management services to maximize the return on your MTS Landmark System investment and help you meet your exact test requirements as quickly as possible.

World-class industrial design

Equipped with our list of customer demands, we embarked upon a world-class industrial design program to create the safest, most efficient and highest performing material testing environment to date.

In-depth Customer Research

Before committing to a new test system design we sat down with servohydraulic test system users around the world, meticulously documenting their requirements and challenges.

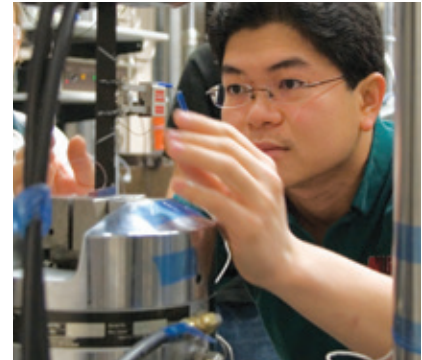

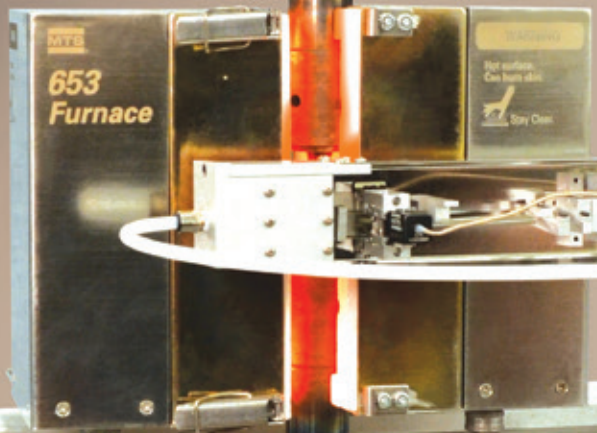
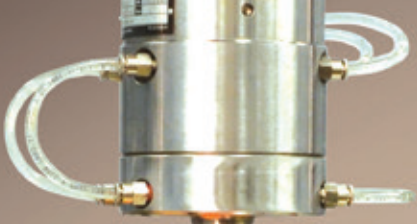

MTS Performance

The global standard for test system precision, reliability and flexibility

Test engineers worldwide rely on MTS testing solutions to achieve unmatched accuracy and flexibility across a wide range of static and dynamic testing applications. The MTS Landmark System marks a continuation of this legacy of excellence. By combining the latest in MTS servohydraulic technology, versatile FlexTest controls, industry-leading MTS software and unparalleled support, the MTS Landmark System takes its place as the world's highest performing and most configurable material test platform.

Proven MTS Servohydraulic Technology

MTS Landmark Systems integrate the latest in MTS servohydraulic technology, including:

- » Innovative MTS 370 load frames that feature extremely stiff and lightweight crossheads with high natural frequencies, and precision-machined columns for consistently tight alignment
- » Fatigue-rated MTS actuators, which employ best-in-class MTS load cells, low-friction Annular Step Bearings, and co-axially mounted Linear-variable Displacement Transducers (LVDT)
- » Trouble-free SilentFlo™ hydraulic power units that are quiet enough to be located directly in the laboratory
- » A family of smooth-ramping hydraulic service manifolds that feature five-port servovalves; proportional, local hydraulic station control; close-coupled accumulators; and Off Low-High-pressure control.



MTS TestSuite™ Software

The MTS Landmark System leverages MTS TestSuite™ Software to provide test definition, test execution and report generation for virtually all types of material tests, including tension, bending and compression testing, fatigue life studies and fracture growth studies.

- » MTS TestSuite™ Software

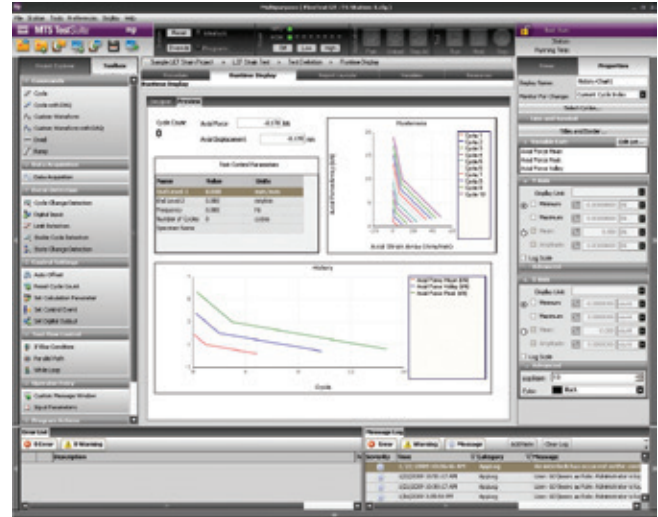

FlexTest Control

Versatile FlexTest controllers provide the flexibility you need to address a full spectrum of testing needs and adapt readily to evolving standards. Scalable and easy-to-use, FlexTest controllers provide the high-speed closed-loop control, data acquisition, function generation and transducer conditioning required to conduct reliable single and multi-channel material and component testing across multiple stations.



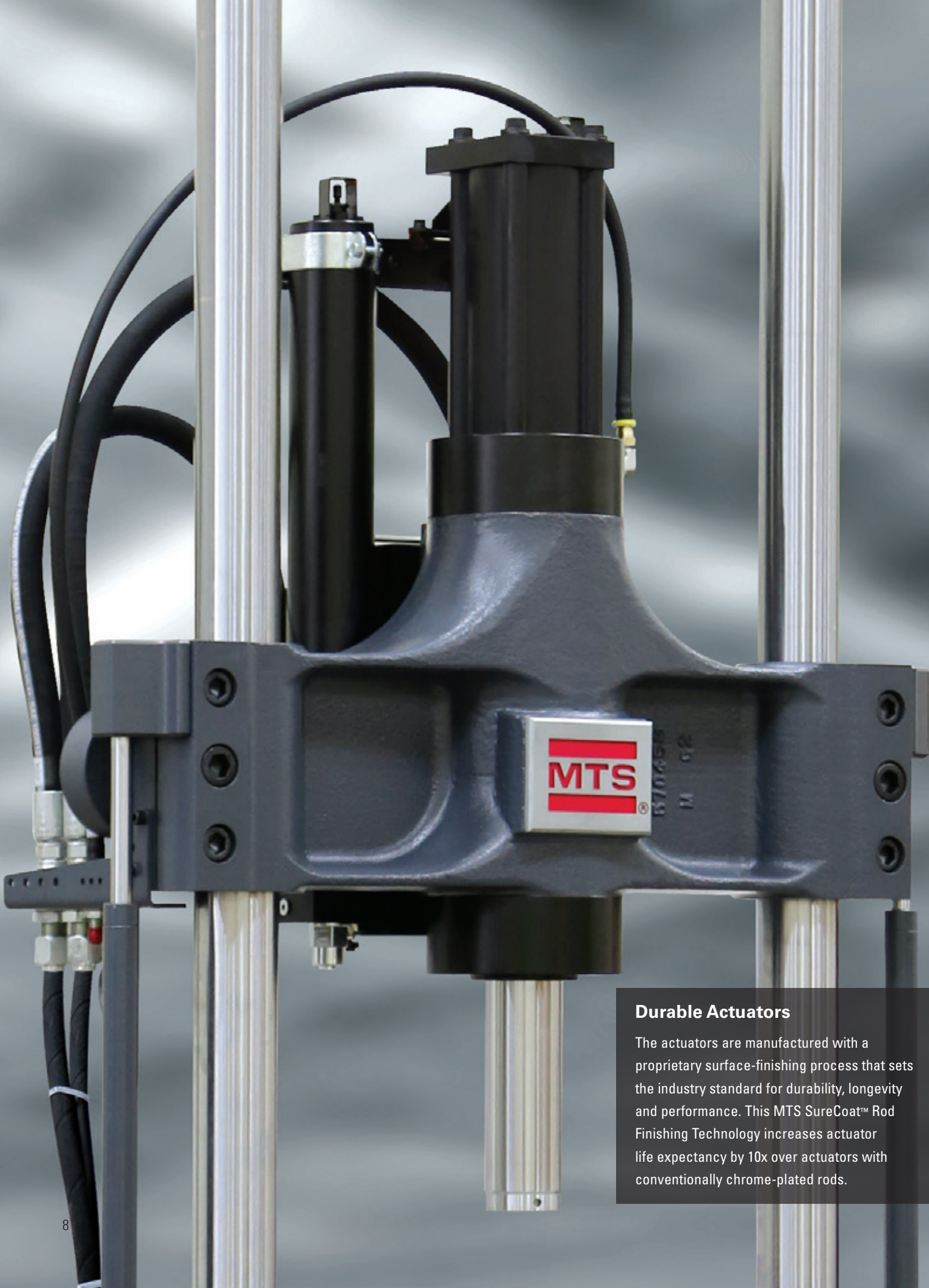

Durable Actuators

The actuators are manufactured with a proprietary surface-finishing process that sets the industry standard for durability, longevity and performance. This MTS SureCoat™ Rod Finishing Technology increases actuator life expectancy by 10x over actuators with conventionally chrome-plated rods.

Innovative Cylinder-Centric Design

Superior stiffness, alignment and ease-of-maintenance

The MTS Landmark System embraces a new approach to load frame design that enhances system reliability and ease-of-maintenance, while delivering the accuracy, repeatability and flexibility that have come to define MTS Performance. The Cylinder-Centric Design approach minimizes the required number of joints, resulting in a load frame that exhibits superior stiffness and alignment. With innovations such as an Integrated Actuator Beam, piloted end-caps and direct actuator porting, this design results in more efficient operation and minimal down-time over the life of your test system.

Integrated Actuator Beam

The Cylinder-Centric Design approach integrates fatigue-rated MTS actuators directly into a cast steel cross-beam to comprise an Integrated Actuator Beam. This minimizes the number of required joints, yielding a frame that exhibits high axial and lateral stiffness and superior reliability. Easy access to both ends of the cylinder facilitates quick and efficient servicing. The Integrated Actuator Beam is also available for crosshead-mounted actuation to deliver the same level of performance and serviceability for test applications requiring the actuator to be positioned above the test space.

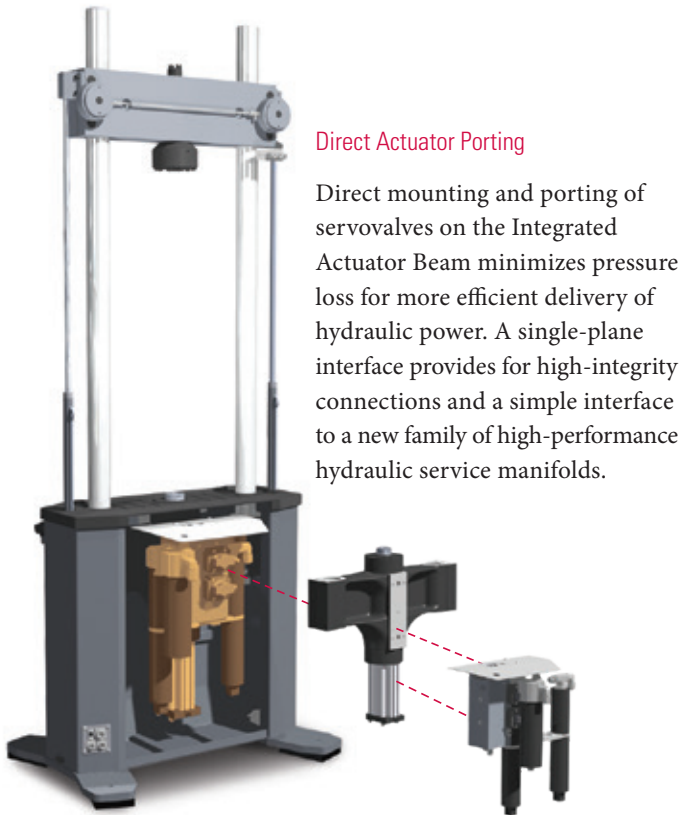

Direct Actuator Porting

Direct mounting and porting of servovalves on the Integrated Actuator Beam minimizes pressure loss for more efficient delivery of hydraulic power. A single-plane interface provides for high-integrity connections and a simple interface to a new family of high-performance hydraulic service manifolds.

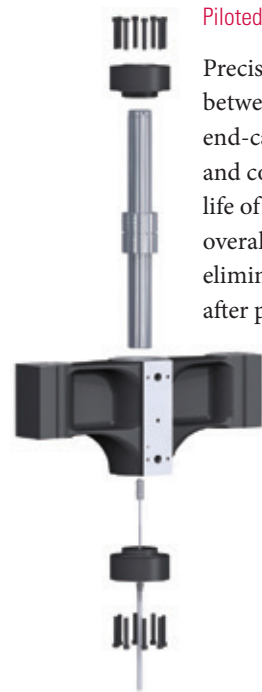

Piloted End Caps

Precision-machined connections between the actuator cylinder and end-caps guarantee extremely tight and consistent alignment over the life of the system, adding to the overall reliability of the actuator and eliminating the need for realignment after periodic maintenance.

Leading-edge Ergonomics

The world's safest, highest performing material test environment

We worked closely with our global customer base to develop a user-friendly testing environment that emphasizes operator well-being, and simplifies test setup and operation. As a result, the MTS Landmark System integrates intuitive, centralized controls, enhanced safety features and a new, highly efficient workspace. This means your operators can safely and reliably perform more tests with fewer damaged or misaligned specimens.

Highly Efficient Workspace

The MTS Landmark System sets a new standard for workspace accessibility and convenience to facilitate efficient specimen installation and test setup. The load frame stand features a wide footprint that provides easy access to the test area, enabling operators to install fixtures and specimens while maintaining an



ergonomic body position. The compact system handset provides the ultimate in test setup convenience, featuring a clear test status display, precision controls for fine actuator positioning and an ergonomic design for both right- and left-handed operators.



Enhanced Safety Features

MTS Landmark systems offer a variety of safety features that can protect operators and comply with international safety directives.

- » **ACTUATOR VELOCITY LIMITING CIRCUIT** - restricts the actuator's speed as it moves into test position, preventing unexpected motion that could injure operators
- » **AVAILABLE INTEGRATED TEST AREA ENCLOSURE** - limits access to the test space during testing to enhance operator and overall lab safety
- » **DOUBLE-ACTING CYLINDERS** provide tight control of crosshead lifting and lowering to ensure safe operation and reduce test setup time

Intuitive Centralized Controls

MTS Landmark System controls are designed to keep operators focused on the test space while setting-up tests. Conveniently located to eliminate any need for awkward bending and long reaching, they feature easy-to-turn handles and clear, universally-understood labeling.



Streamlined System Procurement

Ensuring that your specific requirements will be met in as little time as possible



Easy System Configuration

Straightforward system configuration allows you to efficiently weigh test system features and costs with your MTS sales engineer in real-time. You'll quickly match the appropriate standard available platform options with the right mix of MTS testing accessories to meet your exact testing needs. A dedicated manufacturing team and facility guarantees that all MTS Landmark orders enjoy quick and reliable turnaround.

Broad Selection from a Single Platform

Choose the right system for your particular test program and budget from among the broad selection of MTS Landmark standard available options. These include a wide selection of performance factors such as hydraulic flow and accumulation, force rating and actuator stroke, as well as numerous additional options, including:

- » Extended vertical test space
- » Hydraulic crosshead positioning
- » Hydraulic crosshead locks
- » Integrated grip controls
- » Crosshead-mounted actuator
- » MTS 252 Servovalves
- » Hydrostatic bearings
- » Actuator anti-rotation
- » Column-stiffening tie bar
- » Test area enclosure
- » Alignment fixture

	Manifold Description	Application Notes
<p>Single Purpose</p>  <p>Up to 57 lpm (15 gpm)¹</p>	<p>The single MTS Series 252 Servovalve mounting on this manifold is appropriate for systems that will perform basic tests.</p>	<ul style="list-style-type: none"> » Basic tension » Basic compression » Tension/compression cyclic tests » Bend tests » Creep tests
<p>Multipurpose</p>  <p>Up to 114 lpm (30 gpm)¹</p>	<p>This manifold enables a wider range of tests by allowing two standard MTS Series 252 Servovalves to be used independently or simultaneously.</p>	<ul style="list-style-type: none"> » Same basic tests as single purpose manifold, plus... » Higher velocity tension and compression tests » Low- and high-cycle fatigue

¹ Actual performance varies with actuator force rating and stroke that is deployed with the manifold.

The Flexibility to Perform

A Full Spectrum of Material and Component Testing



Fatigue Testing

MTS Landmark systems are ideal for the exacting demands of material fatigue testing. Highly stiff integrated actuator beams, patented hydraulic grips, high resolution force transducers and precision alignment fixtures combine to deliver tightly controlled and consistent through-zero specimen loading. Driven by MTS TestSuite software, these systems perform highly accurate and repeatable low-cycle, high-cycle and advanced low-cycle fatigue testing. Optional Fatigue Analyzer software allows you to glean new insight from post-test data.

TEST EXAMPLES

- » Constant Amplitude
- » Variable Amplitude
- » Block Loading
- » Low Cycle Fatigue
- » High Cycle Fatigue

STANDARDS

- » ISO 12737, 12108, 12135
- » ASTM E399, E647, B645, E1820



Fracture Testing

MTS Landmark systems can be readily configured to perform linear elastic and elastic-plastic fracture toughness testing. The system load frame can be used for both pre-cracking and fracture testing and equipped with a selection of standard-compliant grips and precision clip-on displacement gauges. Easy-to-use application software features templates for testing to various ASTM, ISO and British test standards for fracture toughness and fatigue crack propagation.

TEST EXAMPLES

- » Fracture Toughness
- » Fatigue Crack Growth
- » Crack Propagation
- » K_{Ic}, J_{Ic}

STANDARDS

- » ISO 12737, 12108, 12135
- » ASTM E399, E647, B645, E1820



Component Testing

Highly configurable MTS Landmark systems feature the test space and performance flexibility required to perform both static and dynamic component testing. These systems can be equipped with fixtures for single and multiple specimens, as well as a full selection of extensometers that are versatile enough to measure displacement from a variety of locations on a specimen. Multipurpose TestWare® software provides a powerful yet easy-to-use means for building, running and reporting on even the most complex component tests.

TEST EXAMPLES

- » Durability, Strength and Physical Properties of Components and Assemblies

STANDARDS

- » Various ASTM, ISO, FDA and DIN Standards



Monotonic Testing

Multipurpose MTS Landmark systems are equipped to meet a full spectrum of monotonic—or static - material testing requirements. These systems run industry-leading MTS TestSuite software, which combines powerful test definition capabilities with simplified runtime operation and the ability to analyze data report test results in a variety of standard and custom formats. A comprehensive selection of MTS hydraulic and mechanical grips and fixtures ensures that MTS Landmark systems can address virtually any material static testing need.

TEST EXAMPLES

- » Tensile
- » Compression
- » Bend
- » Stress Relaxation

STANDARDS

- » ISO 6892
- » ASTM E8, E9, E21

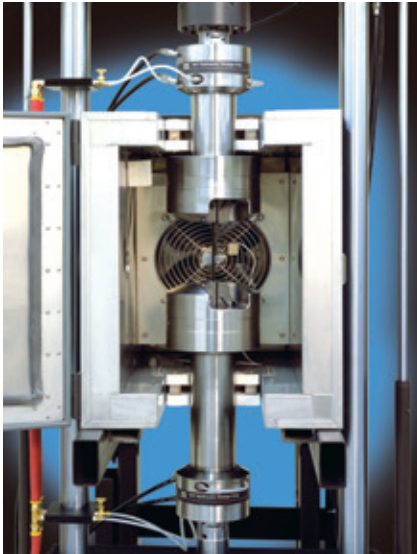

Environmental Testing

Versatile MTS Landmark systems integrate seamlessly with equipment needed to replicate real-world loading at high temperatures and extreme environmental conditions. A flexible test space accommodates high temperature MTS furnaces and chambers, and water cooled grips and extensometers. Third party corrosion and high-humidity environments are also supported. All integrated test environments can be controlled from within the system software.

TEST EXAMPLES

- » Fatigue Testing of Composite Materials
- » Elevated Temperature Fatigue
- » Tensile

STANDARDS

- » ISO 783
- » ASTM D3479, D6115, E8, E606



Thermomechanical Fatigue (TMF) Testing

MTS Landmark systems are easily configured to support the unique requirements of TMF testing. The system's flexible test space supports third-party induction furnaces, water-cooled grips, and a wide range of high temperature extensometers. High resolution force transducers and alignment fixtures enhance system precision and test accuracy. A TMF software toolkit simplifies setup, runtime and post-test analysis. Real-time plots enable the monitoring of wave shapes and advanced properties such as strain hardening or softening as a function of cycles.

STANDARDS

- » ISO/DIS 12111
- » ASTM E2368

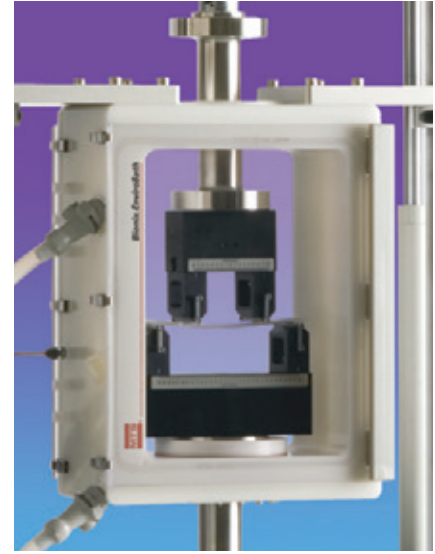

Biomedical Testing

Compact MTS Landmark tabletop systems are ideal for the lower force testing needs of the biomedical industry. These systems are available in an axial configuration for conducting fatigue life studies, and tension, bending and compression tests of biomaterials and components; and an axial torsion (A/T) configuration for testing the durability and wear properties of knee, hip and spine implants, and conducting kinematics studies of orthopaedic constructs. A complete selection of accessories includes stainless steel grips, fixtures and platens; temperature-controlled fluid baths; small extensometers, immersible extensometers; and a variety of multi-degree-of-freedom subsystems.

TEST EXAMPLES

- » Hip Stem Fatigue
- » Dental Implant Wear
- » Bone Screw Fatigue

STANDARDS

- » ASTM F1440, F2118

Floor-Standing Load Frame Features

Versatile, Configurable Floor-Standing Systems

Floor-standing MTS Landmark Systems deliver a broad array of testing capabilities for both low and high force static and dynamic testing. By selecting from a variety of force capacities, servovalve flow ratings, pump capacities, software and accessories, floor-standing systems can be easily configured to meet your specific material or component testing needs.

Floor-standing MTS Landmark systems feature:

- » Actuator force ratings ranging from 15 kN (3.3 kip) to 500 kN (110 kip)
- » A wide performance range—see Performance Curves on pages 14-17
- » The ability to test materials ranging in strength from plastics to aluminum, composites and steel
- » A large test space to accommodate standard, medium and large size specimens, grips, fixtures and environmental subsystems
- » The capability to perform a wide variety of test types, including tensile, high- and low-cycle fatigue, fracture mechanics and durability of components



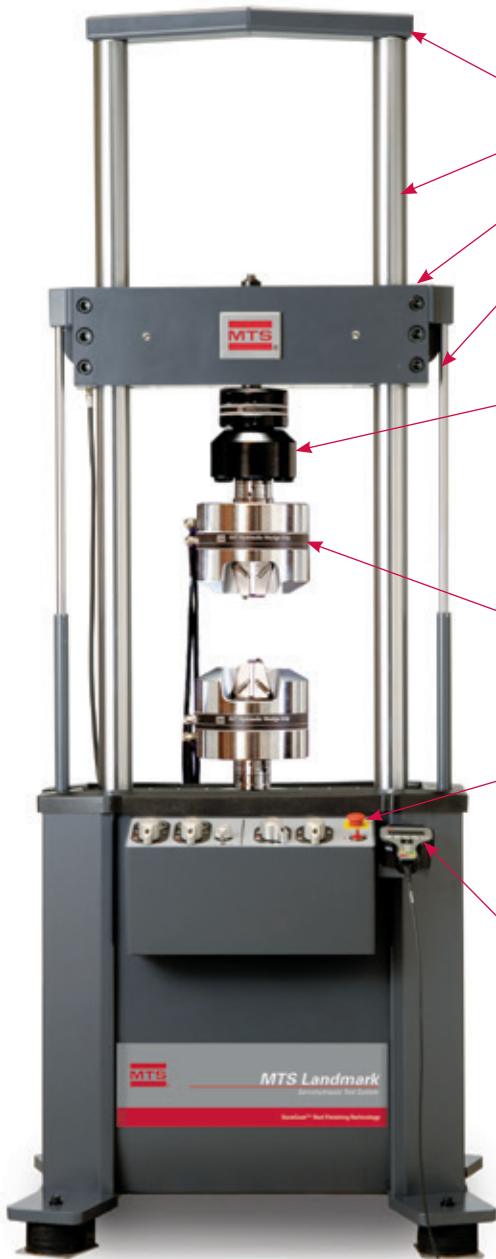

- Optional Tie Bar
- Precision-Machined Columns
- Extremely Stiff, Lightweight Crosshead
- Optional Hydraulically-Powered Crosshead Positioning
 - » Conveniently positioned system controls
 - » Double-Acting Hydraulic Cylinders
 - » Optional Powered Crosshead Locks

- 661 Load Cell
 - » High output, fully fatigue-rated
 - » Noise-reducing wiring
 - » Temperature compensation
 - » Low hysteresis and long-term stability
 - » Accommodates all MTS grips, fixtures and platens

- MTS Accessories
 - » Grips, fixtures, extensometers and test environments for fatigue, thermal mechanical fatigue, fracture, high temperature, component and environmental testing

- Intuitive, Centralized Controls
 - » Easy-to-turn handles
 - » Clear, universal labeling
 - » Actuator Velocity Limiting Switch

- Optional Alignment Fixture

- Optional Control Features
 - » Crosshead Positioning Controls
 - » Specimen Gripping Controls
 - » Ergonomic Handset

- Large, Durable Work Surface

- Wide Variety of Fatigue-Rated Integrated Actuator Beams
 - » Actuator with SureCoat Rod Finishing Technology
 - » Piloted End-caps
 - » Direct Actuator Porting
 - » Low-friction Annular Step Bearings
 - » Coaxial-mounted Linear Variable Differential Transducer (LVDT)

- Broad Selection of Smooth-Ramping Hydraulic Service Manifolds
 - » Actuator Velocity Limiting Circuit
 - » Five-Port Servovalves
 - » Protective Guard
 - » Optional Close-Coupled Accumulators
 - » Optional Local Filter

- Wide, Stable Footprint

- Optional Pneumatic/Elastomeric Vibration Isolation Mounts

OTHER AVAILABLE OPTIONS

- » Integrated test area enclosure
- » Crosshead-mounted actuator
- » Extended vertical test space
- » Hydrostatic pad bearings
- » Actuator anti-rotation
- » Low-force load cells

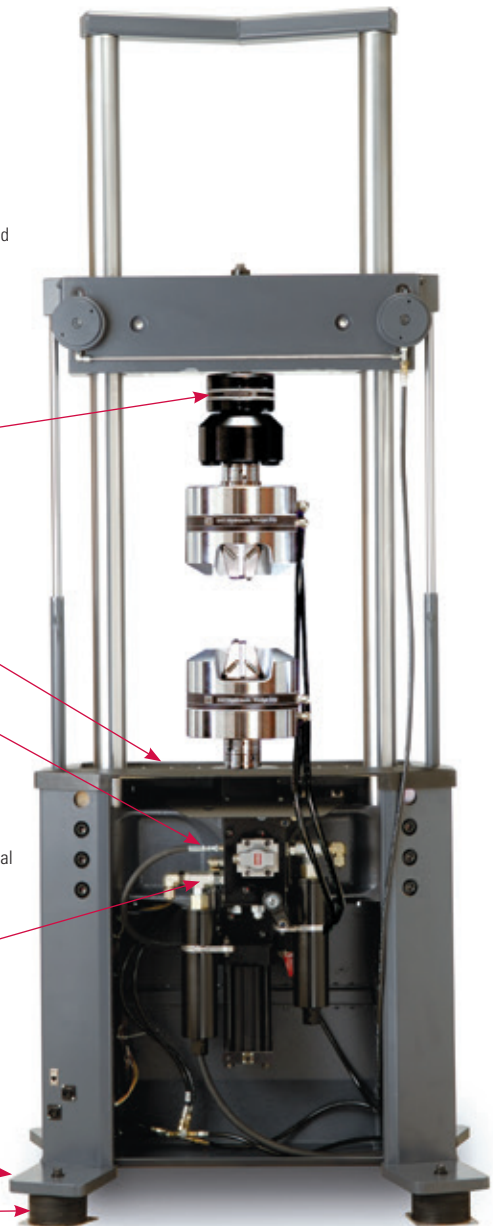

Floor-Standing Load Frame Specifications

Load Frame Specifications ₁	Diagram Detail	Units	MODEL					
			370.10		370.25		370.50	
			Actuator integral to Base	Actuator integral to Crosshead	Actuator integral to Base	Actuator integral to Crosshead	Actuator integral to Base	Actuator integral to Crosshead
Force capacity (rated dynamic force)		kN (kip)	100 (22)	100 (22)	250 (55)	250 (55)	500 (110)	500 (110)
Available actuator ratings ₁ (nominal)		kN (kip)	15, 25, 50, 100 (3.3, 5.5, 11, 22)	15, 25, 50, 100 (3.3, 5.5, 11, 22)	100, 250 (22, 55)	100, 250 (22, 55)	250, 500 (55, 110)	250, 500 (55, 110)
Actuator dynamic stroke ₁		mm (in)	100, 150 , 250 (4, 6 , 10)	100, 150 , 250 (4, 6 , 10)	150 , 250 (6, 10)	150 , 250 (6, 10)	150 (6)	150 (6)
Min vertical test space - standard height ₂	A	mm (in)	140 (5.5)	70 (2.8)	231 (9.1)	159 (6.3)	427 (16.8)	345 (13.6)
Max vertical test space - standard height ₃	A	mm (in)	1283 (50.5)	1213 (47.8)	1621 (63.8)	1549 (61.0)	2085 (82.1)	2002 (78.8)
Min vertical test space - extended height ₂	A	mm (in)	363 (14.3)	292 (11.5)	485 (19.1)	413 (16.3)	NA NA	NA NA
Max vertical test space - extended height ₃	A	mm (in)	1753 (69.0)	1683 (66.3)	2129 (83.8)	2058 (81.0)	NA NA	NA NA
Working height ₄	B	mm (in)	922 _{8, 15} (36.3)	922 ₁₅ (36.3)	922 _{8, 15} (36.3)	922 ₁₅ (36.3)	922 ₁₅ (36.3)	922 ₁₅ (36.3)
Column spacing (test space width)	C	mm (in)	533 (21.0)	533 (21.0)	635 (25.0)	635 (25.0)	762 (30.0)	762 (30.0)
Column diameter	D	mm (in)	76.2 (3.00)	76.2 (3.00)	76.2 (3.00)	76.2 (3.00)	101.6 (4.00)	101.6 (4.00)
Base width	E	mm (in)	1018 (40.1)	1018 (40.1)	1112 (43.8)	1112 (43.8)	1351 (53.2)	1351 (53.2)
Base depth	F	mm (in)	698 (27.5)	698 (27.5)	737 (29.0)	737 (29.0)	896 (35.3)	896 (35.3)
Diagonal clearance - standard height ₅	G	mm (in)	2580 _{8, 11, 15} (101.6)	2649 _{11, 15} (104.3)	3084 _{8, 11, 15} (121.4)	3155 _{11, 15} (124.2)	3629 _{11, 15} (142.9)	3699 _{11, 15} (145.6)
Diagonal clearance - extended height ₅	G	mm (in)	3084 _{8, 11, 15} (121.4)	3153 _{11, 15} (124.1)	3589 _{8, 11, 15} (141.3)	3660 _{11, 15} (144.1)	NA NA	NA NA
Overall height - standard height ₆	H	mm (in)	2588 _{8, 12, 15} (101.9)	3028 _{9, 15} (119.2)	3095 _{8, 14, 15} (121.8)	3490 _{10, 15} (137.4)	3688 (145.2)	3961 (155.9)
Overall height - extended height ₆	H	mm (in)	3058 _{8, 13, 15} (120.4)	3498 _{9, 15} (137.7)	3603 _{8, 14, 15} (141.8)	3998 _{10, 15} (157.4)	NA NA	NA NA
Stiffness ₇		N/m (lbf/in)	467 x 10 ⁶ (2.66 x 10 ⁶)	467 x 10 ⁶ (2.66 x 10 ⁶)	473 x 10 ⁶ (2.7 x 10 ⁶)	473 x 10 ⁶ (2.7 x 10 ⁶)	777 x 10 ⁶ (4.44 x 10 ⁶)	777 x 10 ⁶ (4.44 x 10 ⁶)
Weight		kg (lb)	635 (1400)	820 (1800)	875 (1925)	1095 (2410)	1570 (3455)	1760 (3875)

- All load frame specifications listed in this chart are based upon the actuator ratings and dynamic stroke values indicated by bold text.
- Min Vertical Test Space:** Span between force transducer and piston rod face when fully retracted at beginning of the dynamic stroke; crosshead down, no alignment fixture.
- Max Vertical Test Space:** Span between force transducer and piston rod face when fully retracted at beginning of the dynamic stroke; crosshead up, no alignment fixture.
- Working Height:** Floor to top of work surface; includes standard FabCell isolation.
- Diagonal Clearance:** Column height (far side) to tip of foot with FabCell; tie bar or enclosure not included.
- Overall Height:** From floor, including standard FabCell isolation, to the highest point on crosshead; crosshead fully raised (most common stroke length).
- Measured at typical testing height with hydraulic wedge grips and cylindrical dog-bone specimen.
Typical testing heights per model: Model 370.10 = 750 mm (29.5 in); Model 370.25 = 900 mm (35.5 in); Model 370.50 = 1250 mm (49.2 in)
- Add 178 mm (7 in) to dimensions B, G, & H for 250 mm (10 in) stroke actuators integral to base.
- Add 229 mm (9 in) to dimension H for 250 mm (10 in) stroke actuators integral to crosshead.
- Add 203 mm (8 in) to dimension H for 250 mm (10 in) stroke actuators integral to crosshead.
- For frames with an optional tie bar add 51 mm (2 in) to dimension G.
- For 370.10 frames with standard columns, optional tie bar and actuator integral to base add 14 mm (.53 in) to dimension H.
- For 370.10 frames with extended columns, optional tie bar and actuator integral to base add 51 mm (2 in) to dimension H.
- For 370.25 frames with standard or extended columns, optional tie bar and actuator integral to base add 14 mm (.53 in) to dimension H.
- For load frames with optional pneumatic /elastomeric vibration isolation mounts, add 62 mm (2.44 in) to dimensions B, G, and H.

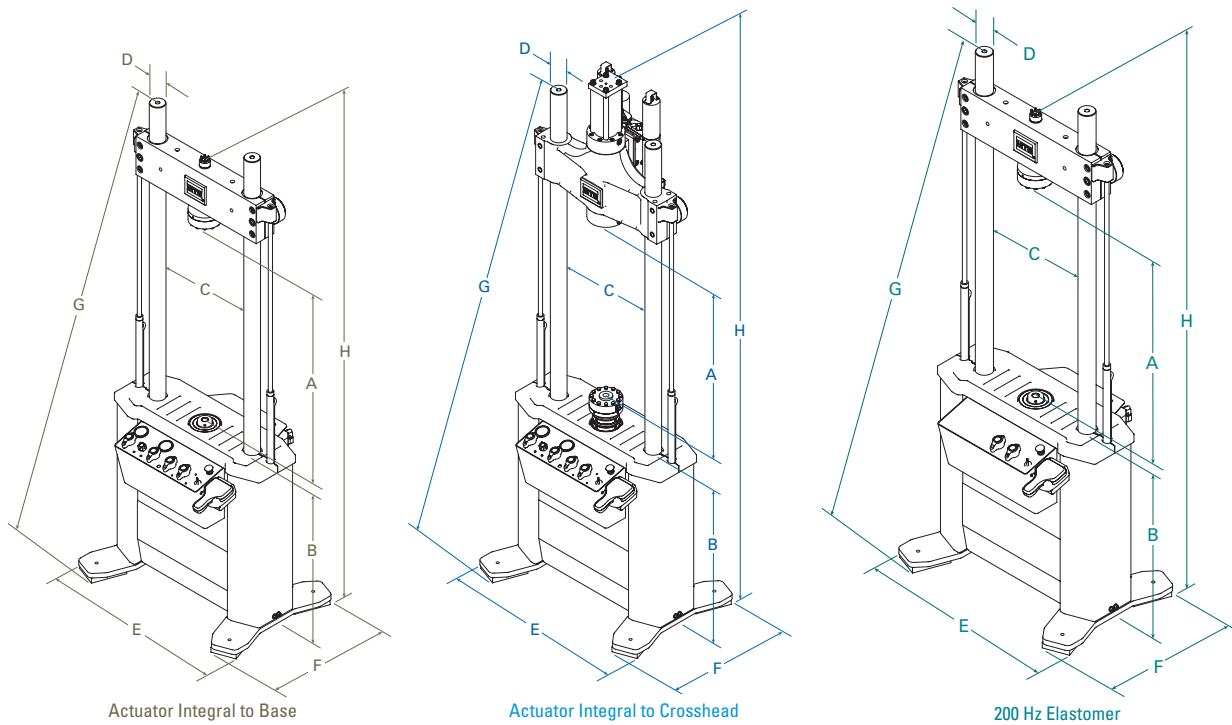

Load Frame Specifications ₁	Diagram Detail	Units	MODEL 370.10 200 Hz Elastomer
Force capacity (rated dynamic force)		kN (kip)	100 (22)
Available actuator ratings ₁ (nominal)		kN (kip)	15, 25 (3.3, 5.5)
Actuator dynamic stroke ₁		mm (in)	100 (4)
Min vertical test space - standard height ₂	A	mm (in)	0 (0)
Max vertical test space - standard height ₃	A	mm (in)	788 (31.0)
Working height ₄	B	mm (in)	922 (36.3)
Column spacing (test space width)	C	mm (in)	533 (21.0)
Column diameter	D	mm (in)	76.2 (3.00)
Base width	E	mm (in)	1018 (40.1)
Base depth	F	mm (in)	698 (27.5)
Diagonal clearance ₅	G	mm (in)	2079 ₈ (81.8)
Overall height ₆	H	mm (in)	2065 ₉ (81.3)
Stiffness ₇		N/m (lb/in)	467 x 10 ⁶ (2.66 x 10 ⁶)
Weight		kg (lb)	635 (1400)

- All load frame specifications listed in this chart are based upon the actuator ratings and dynamic stroke values indicated by bold text.
- Min Vertical Test Space:** Span between force transducer and piston rod face when fully retracted at beginning of the dynamic stroke; crosshead down, no alignment fixture.
- Max Vertical Test Space:** Span between force transducer and piston rod face when fully retracted at beginning of the dynamic stroke; crosshead up, no alignment fixture.
- Working Height:** Floor to top of work surface; includes standard FabCell isolation.
- Diagonal Clearance:** Column height (far side) to tip of foot with FabCell; tie bar or enclosure not included.
- Overall Height:** From floor, including standard FabCell isolation, to the highest point on crosshead; crosshead fully raised (most common stroke length).
- Measured at crosshead height of 750 mm (29.5 in).
- For frames with an optional tie bar add 51 mm (2 in) to dimension G.
- For 370.10 200 Hz elastomer frames with an optional tie bar add 28 mm (1.1 in) to dimension H.

Floor-Standing System Performance Curves*

The graphs on the following pages illustrate the dynamic performance characteristics of a sampling of configurations available for MTS Landmark floor-standing systems (370.10, 370.25, and 370.50). Actual

performance will depend upon the specimen under test and the particular grips, fixtures and components employed by your system. MTS can assist you in configuring a system to meet your specific test requirements.

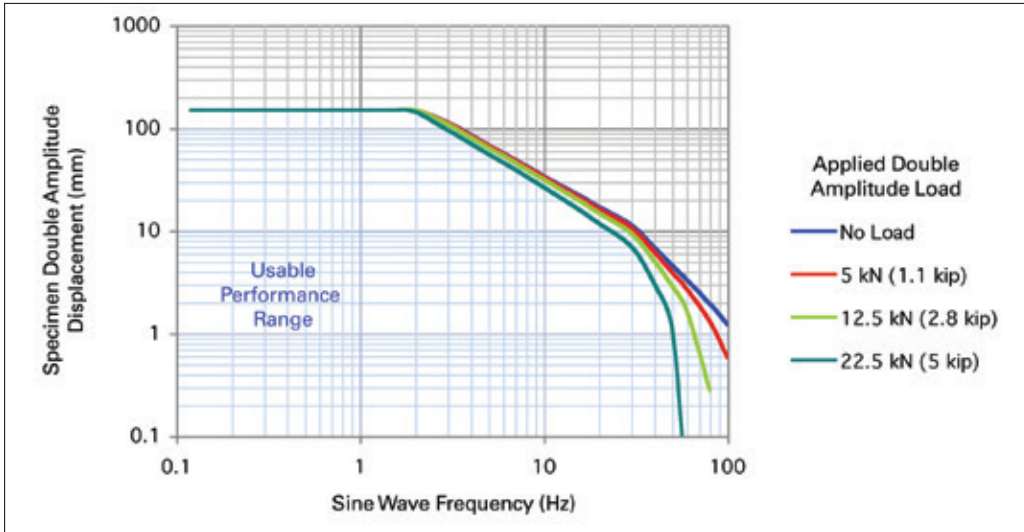

ACTUATOR STATIC FORCE: 25 kN (5.5 kip)
ACTUATOR DYNAMIC STROKE: 150 mm (6 in)

LOAD FRAME MODEL: 370.10
SERVOVALVE(S) FLOW RATING: 57 lpm (15 gpm)

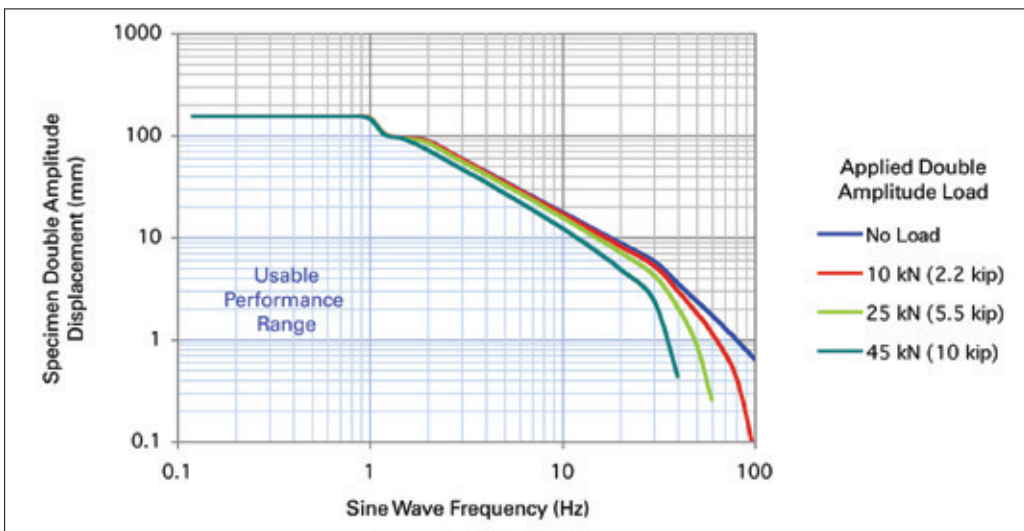

ACTUATOR STATIC FORCE: 50 kN (11 kip)
ACTUATOR DYNAMIC STROKE: 150 mm (6 in)

LOAD FRAME MODEL: 370.10
SERVOVALVE(S) FLOW RATING: 57 lpm (15 gpm)

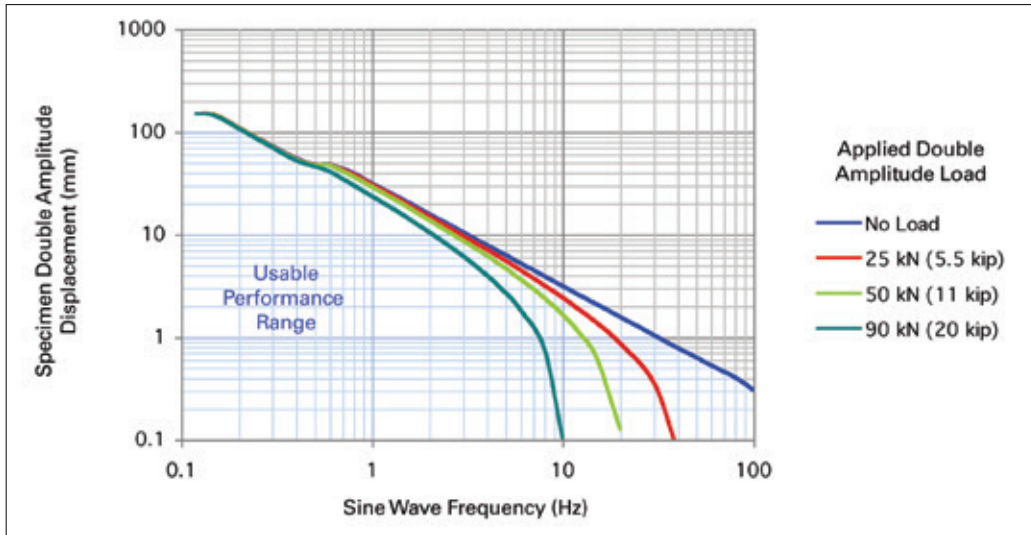

ACTUATOR STATIC FORCE: 100 kN (22 kip)

LOAD FRAME MODEL: 370.10

ACTUATOR DYNAMIC STROKE: 150 mm (6 in)

SERVOVALVE(S) FLOW RATING: 19 lpm (5 gpm)

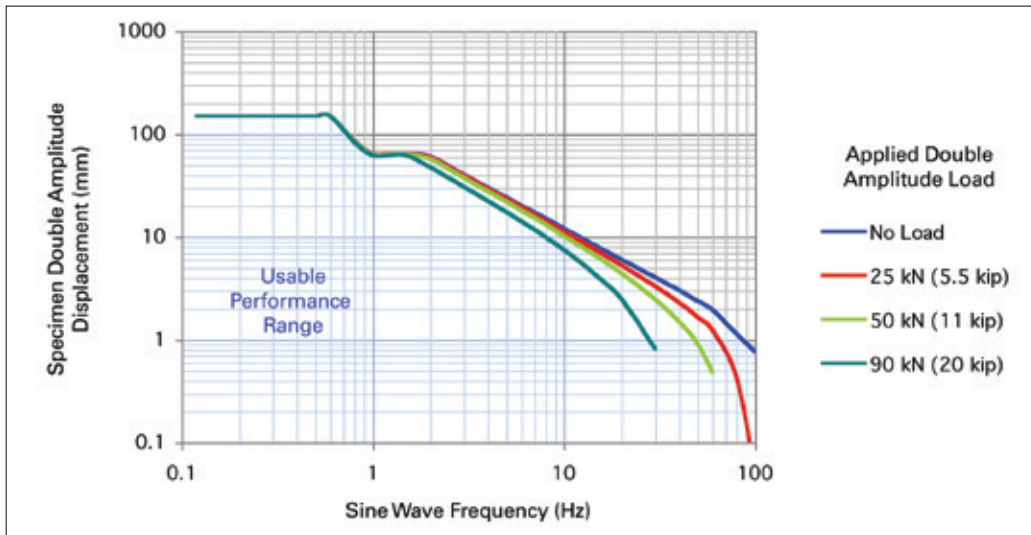

ACTUATOR STATIC FORCE: 100 kN (22 kip)

LOAD FRAME MODEL: 370.10

ACTUATOR DYNAMIC STROKE: 150 mm (6 in)

SERVOVALVE(S) FLOW RATING: 76 lpm (20 gpm)

* Systems profiled feature accumulation, pressure and return hoses selected to match the load frame system configurations. Hydraulic power supplies support 21 MPa (3000 psi) pressure and have been selected to not limit performance provided by other components. The performance curves depicted represent a mathematical prediction of system performance using appropriately-sized hydraulic wedge grips holding a linear spring specimen. Your MTS sales representative can discuss these and other available performance options.

Floor-Standing System Performance Curves* (continued)

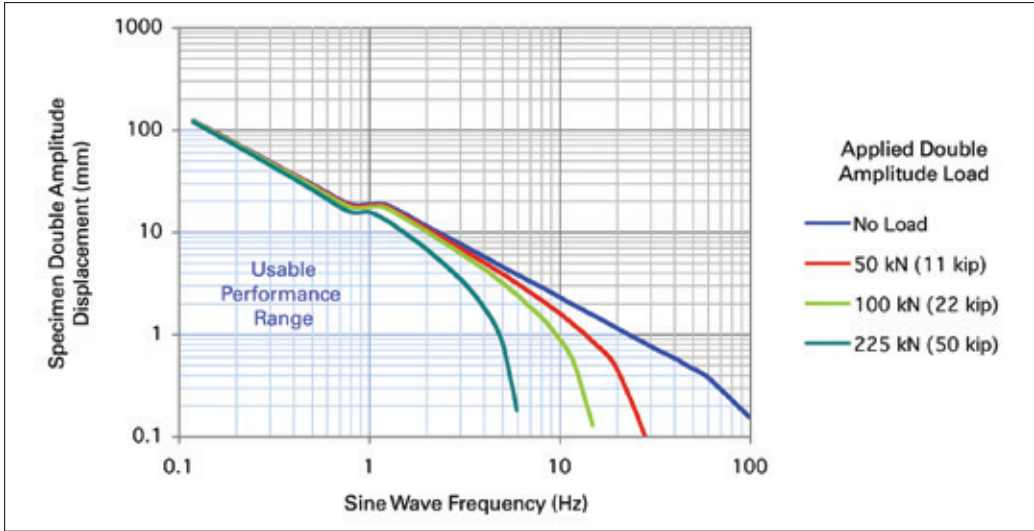

ACTUATOR STATIC FORCE: 250 kN (55 kip) LOAD FRAME MODEL: 370.25
 ACTUATOR DYNAMIC STROKE: 150 mm (6 in) SERVOVALVE(S) FLOW RATING: 38 lpm (10 gpm)

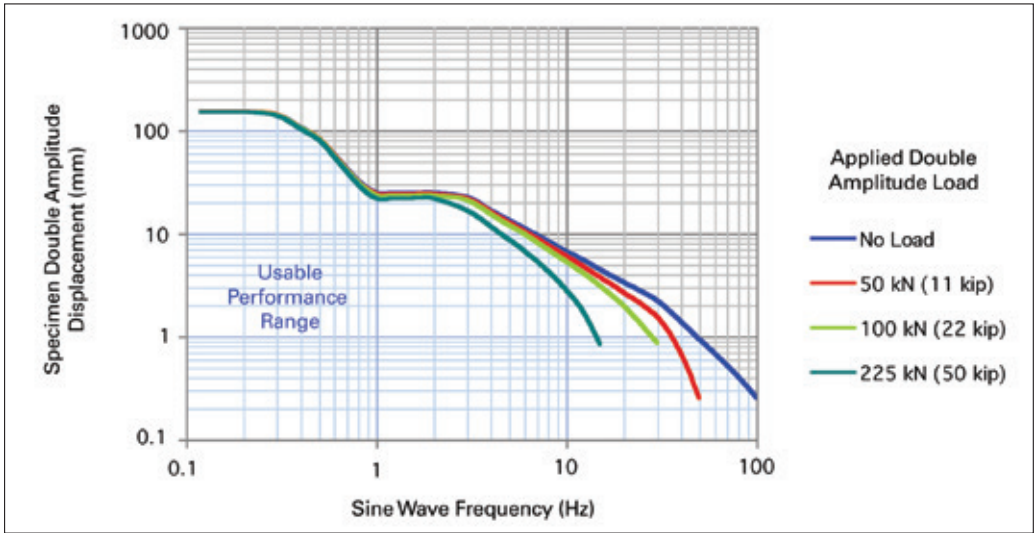

ACTUATOR STATIC FORCE: 250 kN (55 kip) LOAD FRAME MODEL: 370.25
 ACTUATOR DYNAMIC STROKE: 150 mm (6 in) SERVOVALVE(S) FLOW RATING: 114 lpm (30 gpm)

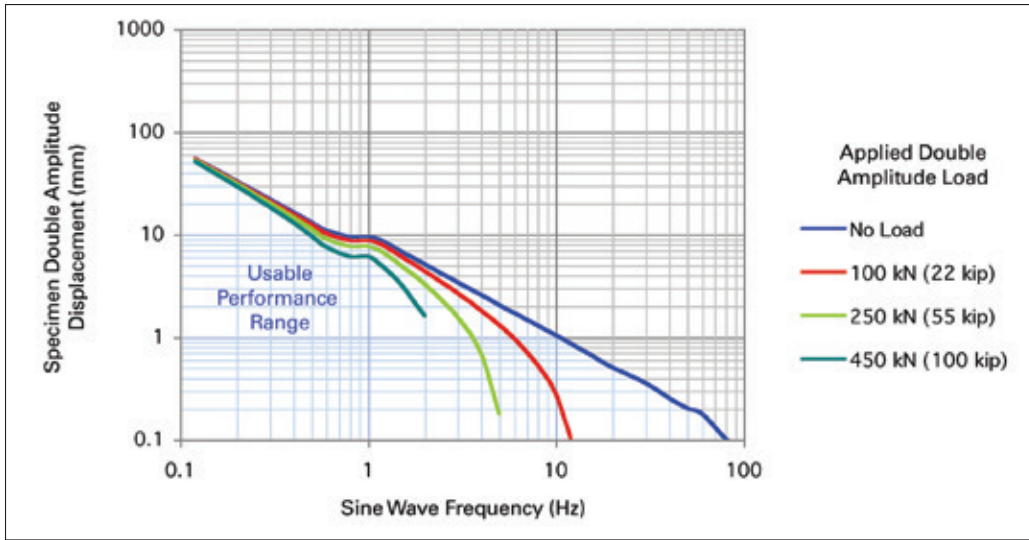

ACTUATOR STATIC FORCE: 500 kN (110 kip) **LOAD FRAME MODEL:** 370.50
ACTUATOR DYNAMIC STROKE: 150 mm (6 in) **SERVOVALVE(S) FLOW RATING:** 38 lpm (10 gpm)

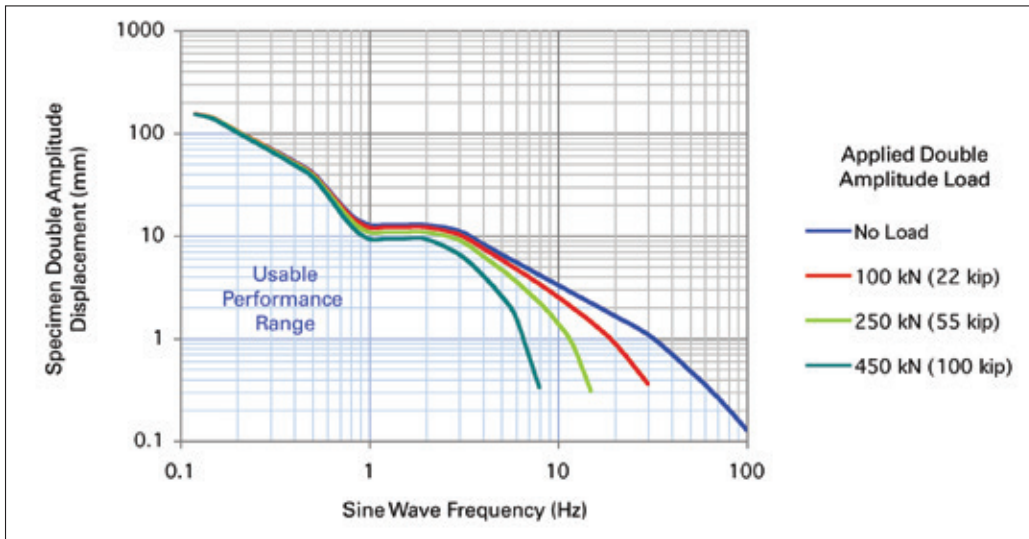

ACTUATOR STATIC FORCE: 500 kN (110 kip) **LOAD FRAME MODEL:** 370.50
ACTUATOR DYNAMIC STROKE: 150 mm (6 in) **SERVOVALVE(S) FLOW RATING:** 114 lpm (30 gpm)

* Systems profiled feature accumulation, pressure and return hoses selected to match the load frame system configurations. Hydraulic power supplies support 21 MPa (3000 psi) pressure and have been selected to not limit performance provided by other components. The performance curves depicted represent a mathematical prediction of system performance using appropriately-sized hydraulic wedge grips holding a linear spring specimen. Your MTS sales representative can discuss these and other available performance options.

Tabletop Load Frame Features

Full Featured, Compact Tabletop Systems

Tabletop MTS Landmark Systems are the cost-effective choice for low-force static and dynamic testing applications. Designed to preserve valuable floor space, tabletop load units fit conveniently on a laboratory bench or portable MTS cart. While extremely compact, Tabletop MTS Landmark systems provide full-featured testing functionality, including:

- » Actuator force ratings ranging from 15 kN (3.3 kip) to 25 kN (5.5 kip)
- » A moderate performance range—see Performance Curves on pages 22-23
- » The ability to test lower strength materials ranging from plastics to aluminum
- » Accommodation of subsized to standard specimens
- » The capability to perform tension, compression, bending and fatigue tests; specialized tests for biomedical and biomechanical testing; and durability testing on small components
- » Wide column spacing to accommodate larger fixtures, environmental chambers and furnaces

OTHER AVAILABLE OPTIONS

- » Integrated test area enclosure
- » Extended vertical test space
- » Actuator anti-rotation
- » Low-force load cells
- » Load frame cart or stand

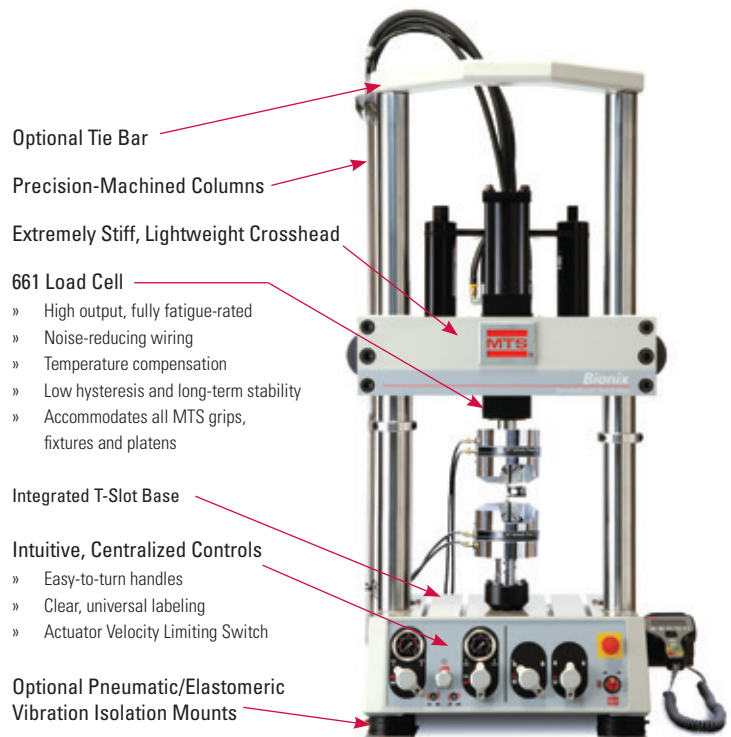

Wide Variety of Fatigue-Rated

Integrated Actuator Beams

- » Actuator with SureCoat Rod Finishing Technology
- » Piloted End-caps
- » Direct Actuator Porting
- » Low-friction Annular Step Bearings
- » Coaxial-mounted Linear Variable Differential Transducer (LVDT)

Smooth-Ramping Hydraulic Service Manifolds

- » Actuator Velocity Limiting Circuit
- » Five-Port Servovalves
- » Protective guard
- » Optional Close-Coupled Accumulators

Optional Hydraulically-Powered Crosshead Positioning

- » Conveniently positioned system controls
- » Double-Acting Hydraulic Cylinders
- » Optional Powered Crosshead Locks

MTS Accessories

- » Grips, fixtures and test environments

Optional Control Features

- » Crosshead Positioning Controls
- » Specimen Gripping Controls
- » Ergonomic Handset

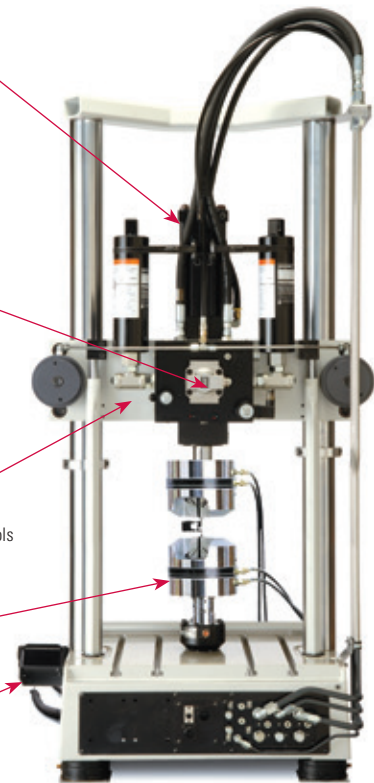

Tabletop Load Frame Specifications

Model 370.02 tabletop load frames are available standard or extended heights with the actuator configured integral to load frame crosshead.

Load Frame Specifications ₁	Diagram Detail	Units	MODEL	
			370.02	370.02 100 Hz Elastomer
Force capacity (rated dynamic force)		kN (kip)	25 (5.5)	25 (5.5)
Available actuator ratings ₁ (nominal)		kN (kip)	15, 25 (3.3, 5.5)	15, 25 (3.3, 5.5)
Actuator dynamic stroke ₁		mm (in)	100, 150 (4, 6)	100, 150 (4, 6)
Min vertical test space - standard height ₂	A	mm (in)	144 (5.7)	144 (5.7)
Max vertical test space - standard height ₃	A	mm (in)	827 (32.6)	827 (32.6)
Min vertical test space - extended height ₂	A	mm (in)	398 (15.7)	398 (15.7)
Max vertical test space - extended height ₃	A	mm (in)	1335 (52.6)	1335 (52.6)
Working height ₄	B	mm (in)	230 ₈ (9.1)	230 ₈ (9.1)
Column spacing	C	mm (in)	460 (18.1)	460 (18.1)
Column diameter (test space width)	D	mm (in)	76.2 (3.00)	76.2 (3.00)
Base width	E	mm (in)	622 (24.5)	622 (24.5)
Base depth	F	mm (in)	577 (22.7)	577 (22.7)
Diagonal clearance - standard height ₅	G	mm (in)	1750 ₈ (68.9)	1750 ₈ (68.9)
Diagonal clearance - extended height ₅	G	mm (in)	2250 ₈ (88.6)	2250 ₈ (88.6)
Overall height - standard height ₆	H	mm (in)	1989 ₈ (78.3)	1989 ₈ (78.3)
Overall height - extended height ₆	H	mm (in)	2624 ₈ (103.3)	2624 ₈ (103.3)
Stiffness ₇		N/m (lb/in)	345 x 10 ⁶ (1.95 x 10 ⁶)	345 x 10 ⁶ (1.95 x 10 ⁶)
Weight		kg (lb)	248 (547)	286 (630)

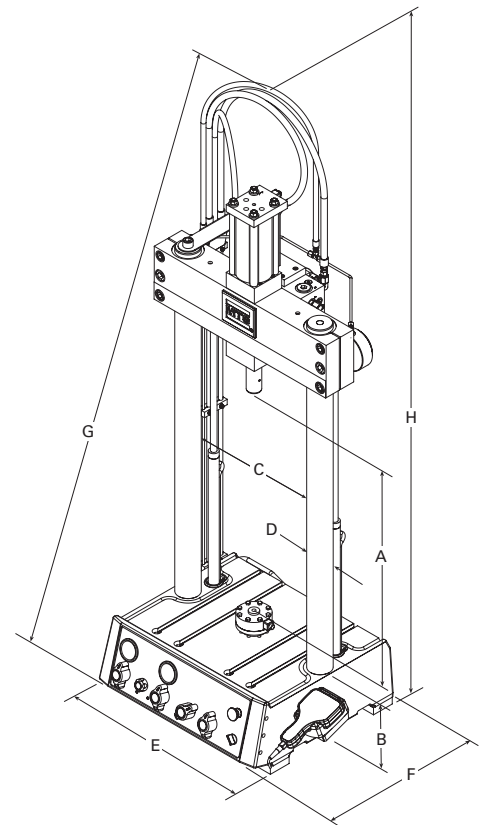

- All load frame specifications listed in this chart are based upon the actuator ratings and dynamic stroke values indicated by bold text.
- Min Vertical Test Space:** Span between force transducer and piston rod face when fully retracted at beginning of the dynamic stroke; crosshead down, no alignment fixture.
- Max Vertical Test Space:** Span between force transducer and piston rod face when fully retracted at beginning of the dynamic stroke; crosshead up, no alignment fixture.
- Working Height:** Floor to top of work surface; includes standard FabCell isolation.
- Diagonal Clearance:** Hose height to tip of foot with FabCell; crosshead down.
- Overall Height:** From floor, including standard FabCell isolation, to top of the hoses or highest point on actuator; crosshead fully raised.
- Measured at crosshead height of 600 mm (23.6 in).
- For load frames with optional pneumatic/elastomeric vibration isolation mounts, add 37 mm (1.44 in) to dimensions B, G, and H.

Tabletop System Performance Curves*

The graphs on the following pages illustrate the dynamic performance characteristics of a sampling of configurations available for MTS Landmark tabletop systems (370.02). Actual performance will depend

upon the specimen under test and the particular grips, fixtures and components employed by your system. MTS can assist you in configuring a system to meet your specific test requirements.

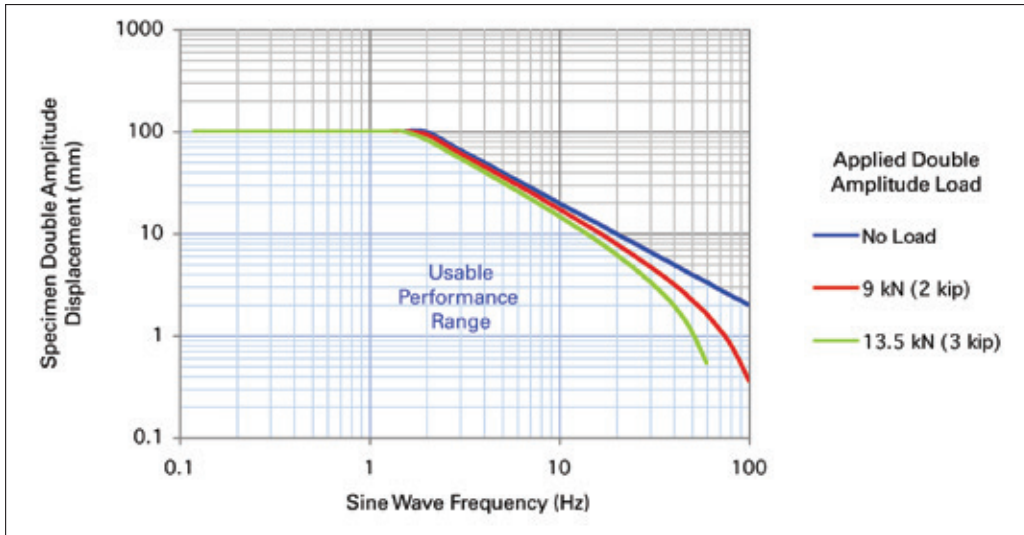

ACTUATOR STATIC FORCE: 15 kN (3.3 kip)
ACTUATOR DYNAMIC STROKE: 100 mm (4 in)

LOAD FRAME MODEL: 370.02
SERVOVALVE(S) FLOW RATING: 19 lpm (5 gpm)

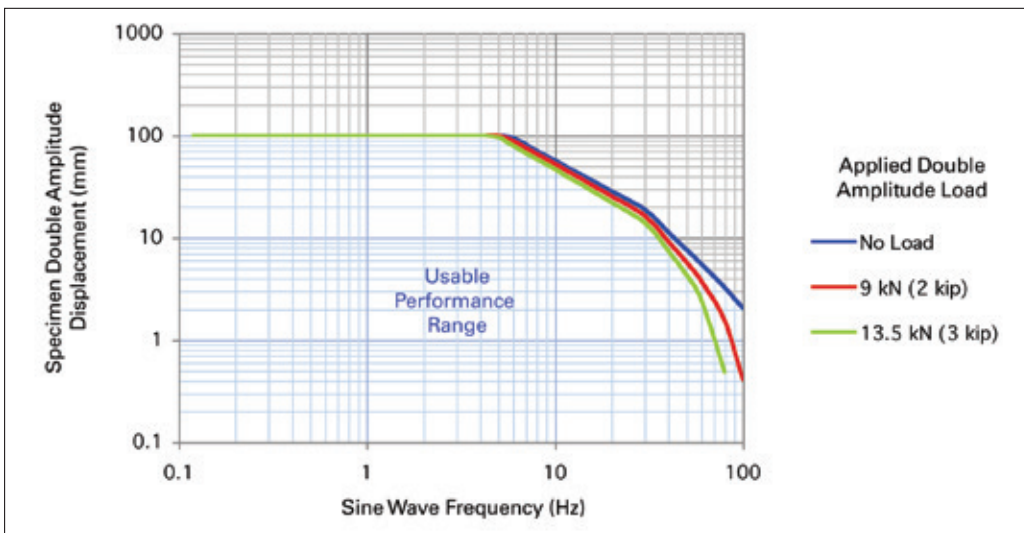

ACTUATOR STATIC FORCE: 15 kN (3.3 kip)
ACTUATOR DYNAMIC STROKE: 100 mm (4 in)

LOAD FRAME MODEL: 370.02
SERVOVALVE(S) FLOW RATING: 57 lpm (15 gpm)

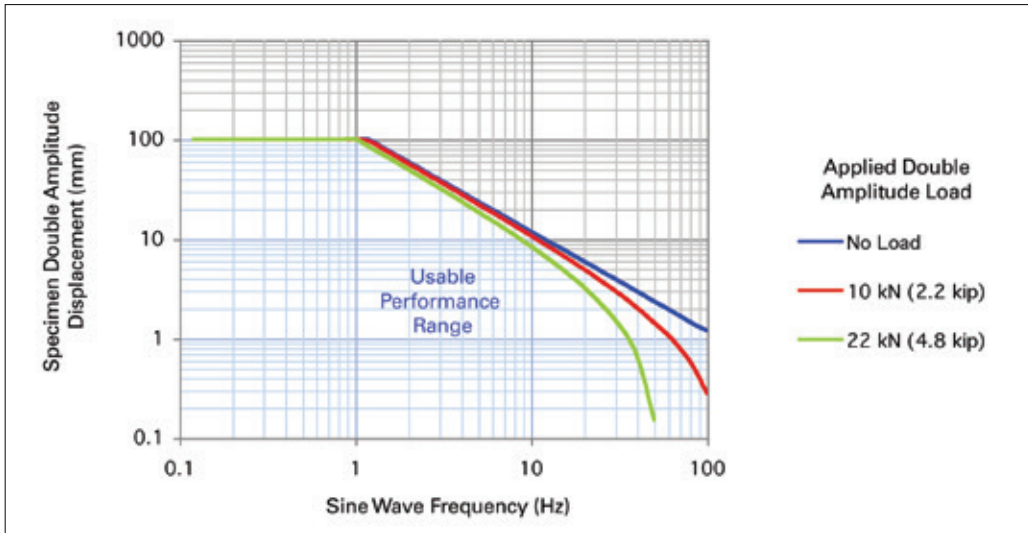

ACTUATOR STATIC FORCE: 25 kN (5.5 kip)
ACTUATOR DYNAMIC STROKE: 100 mm (4 in)

LOAD FRAME MODEL: 370.02
SERVOVALVE(S) FLOW RATING: 19 lpm (5 gpm)

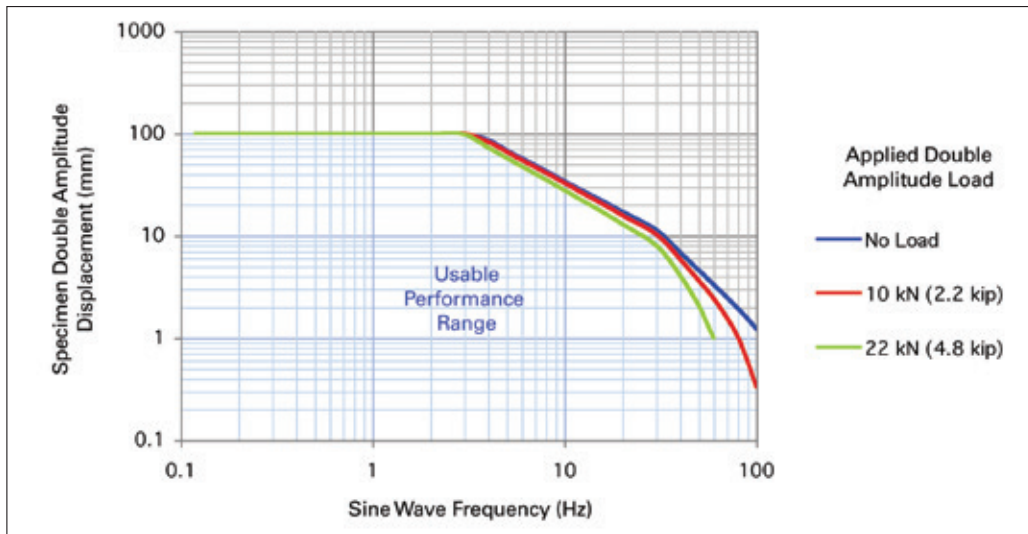

ACTUATOR STATIC FORCE: 25 kN (5.5 kip)
ACTUATOR DYNAMIC STROKE: 100 mm (4 in)

LOAD FRAME MODEL: 370.02
SERVOVALVE(S) FLOW RATING: 57 lpm (15 gpm)

** Systems profiled feature accumulation, pressure and return hoses selected to match the load frame system configurations. Hydraulic power supplies support 21 MPa (3000 psi) pressure and have been selected to not limit performance provided by other components. The performance curves depicted represent a mathematical prediction of system performance using appropriately-sized hydraulic wedge grips holding a linear spring specimen. Your MTS sales representative can discuss these and other available performance options.*

Additional MTS Testing Capabilities

Axial Torsion Testing

MTS Model 809 A/T testing systems feature extremely stiff, high natural frequency load frames with integral axial and torsional actuators. A/T loading of tubular specimens has proven a valuable method for investigating material response to both static and fatigue multi-axial stresses. The MTS Bionix® tabletop A/T system offers similar capabilities for lower force applications. These compact systems are ideally suited for small components, lower strength materials, and a host of biomedical applications, including testing the durability and wear properties of knee, hip and spine implants, and conducting kinematics studies of skeletal tissue and other orthopaedic constructs.



High Force Testing

MTS Model 311 high-force testing systems integrate rigid, 4-column testing units to deliver precise application of high-force/high-displacement loads and fatigue cycles. Highly configurable Model 311 load frames can subject a variety of specimens, components or full-scale test articles to forces ranging from 100 to 3,000 tons or higher. Robust MTS grips, fixtures and transducers are available for large size specimens to complete this high-force test system.



Multiaxial Testing

MTS material testing capabilities include Planar Biaxial and Planar Triaxial Testing Systems. These systems combine modular frame technology, innovative centroid control, advanced alignment and integrated environmental chambers to investigate true, in-plane stress states of materials, or biaxial loading of design elements. System features include high load axis stiffness for low stored energy, and integral actuators with high lateral stiffness to minimize buckling. Powerful features in the FlexTest control software make centroid control easy to implement.

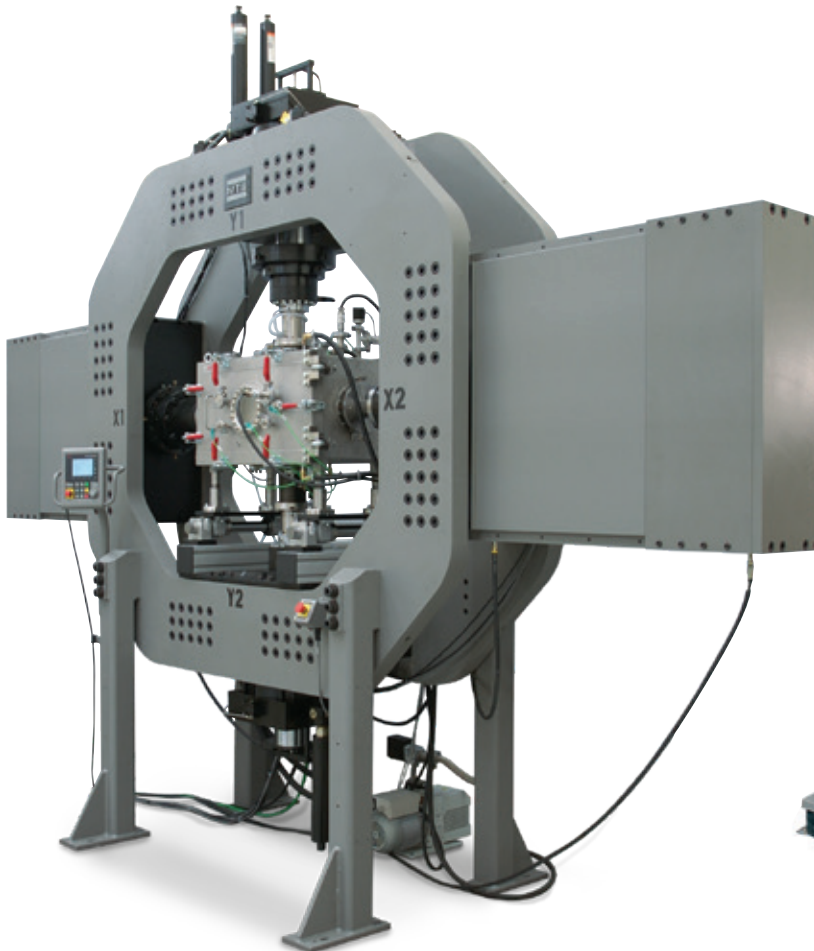

High Rate Testing

Robust, high-performance MTS High Rate systems are used to conduct automotive crash worthiness testing, forging simulation and other high strain rate, or high penetration rate testing. They feature high-response MTS servohydraulics, FlexTest digital controls, high-speed data acquisition, and MTS TestSuite software to provide an intuitive operator interface and flexible test analysis and reporting.



Regional Business Centers

THE AMERICAS

MTS Systems Corporation
14000 Technology Drive
Eden Prairie, MN 55344-2290
USA
Telephone: 952-937-4000
Toll Free: 800-328-2255
E-mail: info@mts.com
Internet: www.mts.com

EUROPE

MTS Systems France
BAT EXA 16
16/18 rue Eugène Dupuis
94046 Créteil Cedex
France
Telephone: +33-(0)1-58 43 90 00
E-mail: contact.france@mts.com

MTS Systems (Germany) GmbH
Hohentwielsteig 3
14163 Berlin
Germany
Telephone: +49-(0)30 81002-0
E-mail: euroinfo@mts.com

MTS Systems S.R.L. a socio unico
Strada Pianezza 289
10151 Torino
Italy
Telephone: +39-(0)11 45175 11 sel. pass.
E-mail: mtstorino@mts.com

MTS Systems Norden AB
Datavägen 37b
SE-436 32 Askim
Sweden
Telephone: +46-(0)31-68 69 99
E-mail: norden@mts.com

MTS Systems Limited
98 Church Street,
Hunslet,
Leeds
LS102AZ
United Kingdom
Telephone: +44 (0) 113 270 8011
E-mail: mtsuksales@mts.com

ASIA/PACIFIC

MTS Japan Ltd.
Raider Bldg. 3F 3-22-6,
Ryogoku, Sumida-ku,
Tokyo 130- 0026
Japan
Telephone: +81 3 5638 0850
E-mail: mts-j-info@mts.com

MTS Korea, Inc.
2nd F, Bundang Yemiji Building, 31,
Hwangsaeul-ro 258beon-gil,
Bundang-gu, Seongnam-si,
Gyeonggi-do, 13595
Korea
Telephone: +82-31-728-1600
E-mail: mtsk-info@mts.com

MTS Systems (China) Co., Ltd.
Floor 34, Building B,
New Caohejing International
Business Center,
No.391, Guiping Road,
Xuhui District
Shanghai 200233
P.R.China
Telephone: +021-24151000
Market: +021-24151111
Sales: +021-24151188
Service: +021-24151198
E-mail: MTSC-Info@mts.com

MTS Testing Solutions Pvt Ltd.
Unit No. 201 & 202, Second Floor
Donata Radiance,
Krishna Nagar Industrial Layout,
Koramangala, Bangalore - 560029
Karnataka, India
Telephone: + 91 80 46254100
Email: mts.india@mts.com



MTS Systems Corporation
14000 Technology Drive
Eden Prairie, MN 55344-2290 USA

ISO 9001 Certified QMS
<http://www.mts.com>

MTS, Bionix, FlexTest, TestWare and MTS Landmark are registered trademarks and MTS TestSuite and SilentFlo are trademarks of MTS Systems Corporation in the United States. These trademarks may be protected in other countries. RTM No. 211177.

©2023 MTS Systems Corporation
100-208-202f LandmarkSolutions Printed in U.S.A. 8/23